



Hydraulic Works



Roads & Railways



Building Structures



Drainage Systems



Waste Disposals

Earth Structures
(Palm Islands Dubai)



WINNING TOGETHER

Fibertex Geotextiles

Design, use and installation guidelines

Contents

1. Introduction	4
	1.1 Background 4
	1.2 Fibertex Geotextiles – references 5
2. Materials and production methods	5
	2.1 Materials 5
	2.2 Production methods 6
	2.3 Designing a nonwoven geotextile 7
3. Standards, approvals and CE-marking	8
	3.1 Background 8
	3.2 European market 8
	3.3 National requirements within Europe 9
	3.4 Fibertex and certifications 10
	3.5 Fibertex Q-Match 10
4. Geotextile applications, functions and characteristics	12
	4.1 Applications 12
	4.2 Functions 13
	4.3 Applications and main functions 14
	4.4 Characteristics 15
	4.5 Approach when designing with geotextiles 16
5. Functions of geotextiles – in detail	17
	5.1 Background 17
	5.2 Separation and filtration 17
	5.3 Drainage 25
	5.4 Protection 28

6. Damage during installation and required mechanical strength during lifetime 32



6.1 Background 32

6.2 Energy Index (based on tensile test according to EN ISO 10319) 33

6.3 Static puncture resistance (EN ISO 12236) 33

6.4 Theoretical model 34

6.5 Practical approach for Fibertex Geotextiles 35

6.6 Fibertex design approach 35

6.7 Drainage trench installations 36

6.8 Example – drainage trench 37

6.9 Hydraulic structures 38

6.10 Example – coastal protection 39

6.11 Road construction 40

6.12 Example – road construction 41

7. Durability requirements to geotextiles 42



7.1 Background 42

7.2 Resistance to weathering 42

7.3 Resistance to microbiological degradation 43

7.4 Resistance to chemical degradation and oxidation 44

7.5 Durability – minimum requirements 44

8. Handling, storage and installation 45



8.1 Handling and storage 45

8.2 Installing geotextiles 46

8.3 Joints and overlaps 46

9. Fibertex calculation tools 47

Appendix A 48

Symbols 49

References 50

1 Introduction

1.1 Background

The purpose of this design guide is to provide designers, engineers, installers and users with guidance and help in the design, use and installation of geotextiles.

The use of geotextiles is well-known, and is becoming an increasingly integrated part of structural designs and solutions. The idea is not new; in fact, stabilising and reinforcing structures using straw or wood has been done for more than a 1,000 years. One example of this is the Great Wall of China, pictured in Figure 1.1.



Figure 1.1 The Great Wall of China, an example of a stabilised/reinforced structure.

Fibertex Nonwovens offers a full range of nonwoven geotextiles designed for use in many different civil engineering structures. The most common applications are:



Hydraulic works



Roads and railway structures



Construction works



Earth structures



Drainage and filtration systems



Waste disposals

Fibertex Nonwovens

Fibertex Nonwovens is a market leading manufacturer of nonwovens for the industrial and technical industry. With corporate office in Aalborg, Denmark, and manufacturing sites in Denmark, the Czech Republic, France, the USA, Turkey and South Africa, Fibertex is globally represented. Since its foundation in 1968, Fibertex has continuously expanded and today manufactures nonwovens for customers all over the world for many different applications.

As a pioneering company with more than 40 years of experience in needlepunch and spunmelt technologies, and in-depth knowledge achieved by participating in global projects and committees enable Fibertex Nonwovens to offer our customers unique technical service and assistance. Further, Fibertex's ongoing R&D effort keeps our products continuously up-to-date.

The starting point is a wide range of products used for various business areas: Acoustics, Automotive, Bedding, Building Industry, Composites, Concrete, Filtration, Flooring, Furniture, Geotextiles, Horticulture, Home & Garden

1.2 Fibertex Geotextiles - references

Fibertex Geotextiles have proven their quality and strength in a large number of projects worldwide. One example is the building of the Palm Islands in Dubai, as shown in Figure 1.2, for which Fibertex delivered geotextiles for the hydraulic structures.

Moreover, Fibertex supplied geotextiles for the land reclamation structures for the Great Belt Link, a bridge and tunnel project between Funen and Zealand in Denmark; see Figure 1.3.



Figure 1.2 Fibertex Geotextiles were used in the Palm Islands



Figure 1.3 The Great Belt Link in Denmark

More information on Fibertex Geotextiles can be found at www.fibertex.com. All business cases are available in PDF format in German, English, French, Spanish and Czech.

2. Materials and production methods

2.1 Materials

The Fibertex F-range of geotextiles is made of fibres of virgin PP (polypropylene) material. Polypropylene is a by-product of oil refining processes.

Polypropylene is a thermoplastic material, which means it can be processed and melted at the high temperatures which are used at different steps of the production process: producing fibres and thermal bonding of the nonwoven.

The following are some of the main characteristics of polypropylene:

- Excellent resistance to stress and high resistance to cracking (i.e. high tensile and compressive strength)
- High operational temperatures with a melting point of 160°C
- Highly resistant to most alkalis and acids, organic solvents, degreasing agents and electrolytic attack
- Non-toxic
- Non-staining

2. Materials and production methods

2.1 Materials

The Fibertex F-range of geotextiles is made of fibres of virgin PP (polypropylene) material. Polypropylene is a by-product of oil refining processes.

Polypropylene is a thermoplastic material, which means it can be processed and melted at the high temperatures which are used at different steps of the production process: producing fibres and thermal bonding of the nonwoven.

The following are some of the main characteristics of polypropylene:

- Excellent resistance to stress and high resistance to cracking (i.e. high tensile and compressive strength)
- High operational temperatures with a melting point of 160°C
- Highly resistant to most alkalis and acids, organic solvents, degreasing agents and electrolytic attack
- Non-toxic
- Non-staining

2.2 Production methods

Fibertex Geotextiles production is an area of continuous development.

The needlepunch production technology, also known as dry-laid technology, is based on a two-step process. First, polypropylene resin is extruded into fibres. Secondly, these fibres are carded and needlepunched and then bonded thermally to form nonwovens.

The finished nonwovens come in widths up to 6 metres.

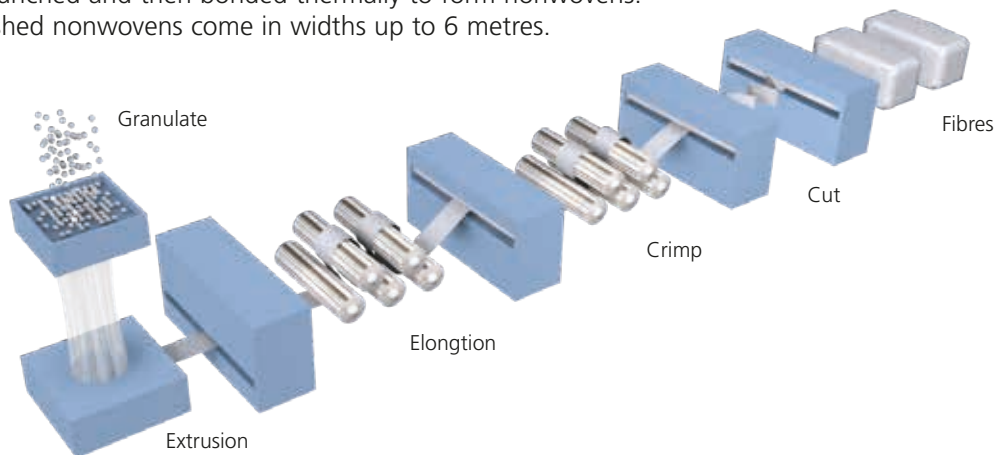

Figure 2.1 Diagram of fibre production

From granules to fibres – step by step

- Granulate: Production of staple fibres. PP granules are fed into the fibre extrusion line.
- Extrusion: The PP granules are melted, extruded and spun into endless PP fibres.
- Elongation: During the elongation process, the endless fibres are stretched in order to obtain specific qualities and characteristics.
- Crimp: The endless PP fibres go through a crimping process to make the fibres soft and more textile-like.
- Cut: The endless PP fibres are cut into short fibres, ready to be baled into staple fibres.
- Fibres: The PP fibres are pressed into staple fibre bales, ready to be used in needlepunch production.

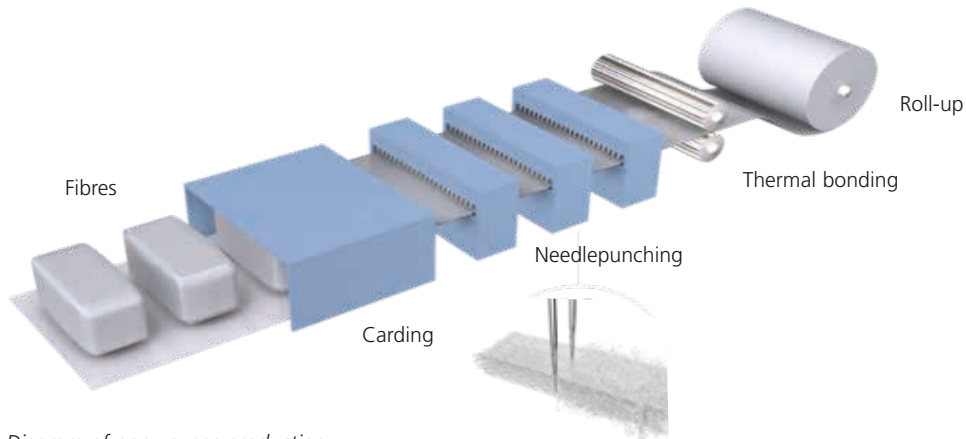

Figure 2.2 Diagram of nonwovens production

From fibre to nonwoven – step by step

- Fibres: Dry-laid needlepunch technology. The fibre bales are loaded into the staple fibre bale opening.
- Carding: In the carding section, the fibres are separated and distributed onto the production line, forming a loose, yet coherent fibre web material.
- Needle punching: After carding, the fibres are mechanically bonded by means of a needlepunching process that makes the fabric tight and flexible.
- Thermal bonding: The fabric is thermally bonded and stretched to form the required nonwoven fabric with optimum capabilities re strength, surface structure etc.
- Roll-up: Finally, the fabric is scanned for quality control and rolled up and wrapped in protective foil.

2.3 Designing a nonwoven geotextile

When designing a geotextile for a given application, it is extremely important that the geotextile’s expected functions are known in advance. Based on this, it is possible to specify exactly the required characteristics of the geotextile by ensuring the correct design:

- Select the appropriate raw material and material properties.
- Select the right stabilisation of the raw material to ensure high durability.
- Select the right fibre length and thickness.
- Select the appropriate design of the needling process.
- Select the right level of thermal bonding to ensure the required strength, elongation and abrasion resistance.

Fibertex Geotextiles are unique due to the right combinations of the above-listed parameters. After being laid out horizontally, the intensive needling ensures that the fibres are fixed vertically. The result is a strong and flexible three-dimensional product which offers clear advantages in terms of all the parameters related to geotextiles, creating a true **“geo textile”** in combination with the surrounding soil. Figure 2.3 shows an illustration of the three-dimensional nonwoven product.

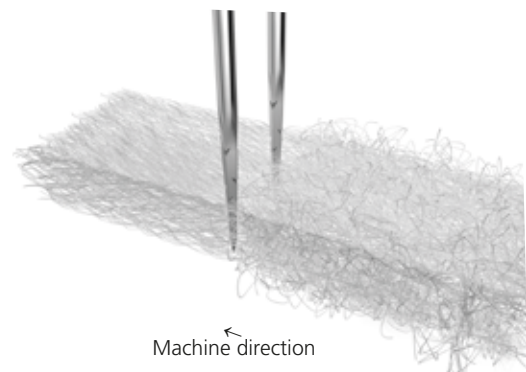

Figure 2.3 Fibertex three-dimensional geotextile

3. Standards, approvals and CE-marking

3.1 Background

Fibertex Nonwovens A/S is a worldwide supplier of geotextiles, and as such meets the requirements of different markets and regions. The testing and evaluation of the characteristics of the geotextiles is mainly made with reference to:

- EN standards, which are obligatory throughout Europe.
- ISO standards, which are recognised worldwide.
- ASTM standards, which are US standards, but which are also used extensively in the Middle East, Far East and in Africa.

Fibertex products are tested and assessed according to the above standards, and product datasheets are available at the Fibertex website.

3.2 European market

For the European market, the products are CE-marked, based on harmonised EN standards. The harmonised standards cover the essential requirements, as defined by the European Commission in the CPD (Construction Product Directive – soon to become CPR Construction Product Regulation). Figure 3.1 shows the relation between EN, ISO and ASTM and other national standards.

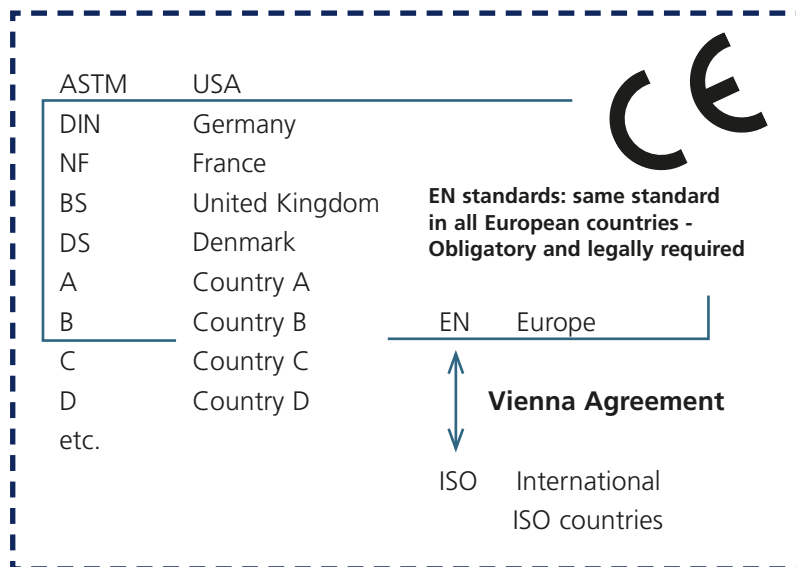

Figure 3.1 CE-marking replaces national standards within Europe.

As a part of the CE-marking, different attestation levels are set up based on a risk analysis, evaluating the consequences and risks if the product fails. For geotextiles, the attestation level is 2+ for the functions "filtration", "drainage", "protection" and "reinforcement", and level 4 for the function "separation". As the function "separation" is never specified alone, the attestation level required for geotextiles is, in practice, always 2+.

Attestation of conformity		Evaluation of product		Factory production control (FPC)	Evaluation of Factory Production Control	
		Initial type testing	Tests on random sampling		Initial inspection of factory and FPC	Continuous surveillance of FPC
Certification	1+	Third party	Third party	Producer	Third party	Third party
	1	Third party	Producer	Producer	Third party	Third party
	2+	Producer		Producer	Third party	Third party
Declaration	2	Producer		Producer	Third party	Third party, if any
	3	Third party		Producer	-	-
	4	Producteur		Producer	-	-

Figure 3.2 CE-marking and attestation levels

This means that CE-marking (attestation level 2+) of a geotextile gives the user or purchaser the following quality assurance, see Figure 3.2:

- Certification of Factory Production Control (FPC) by approved third party
- Declaration of conformity by the manufacturer
- Initial type test by the manufacturer
- Factory Production Control by the manufacturer
- Testing of samples according to test plan by the manufacturer
- Continuous surveillance of FPC by approved third party

In many countries and regions, CE-marking is regarded as insufficient for products used in structures and construction works with long lifetimes and high safety levels. This has led to the development of several national or regional quality certification systems.

3.3 National requirements within Europe

As a supplement to CE-marking national requirements, which include specific requirements to quality assurance and third-party evaluation, have been set up in several countries and regions. The Fibertex range of products includes products which are certified according to these national/regional requirements:

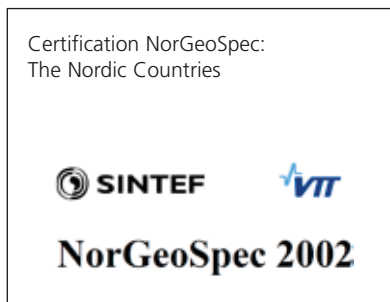

3.4 Fibertex and certifications

The focus of the national/regional certification systems closely matches Fibertex’s strategy as a producer and supplier of high-quality products. This also means that the general production, logistics and sales systems are set up to meet this higher level of quality assurance, which is an integral part of the different national certification systems, as shown in Figure 3.3.

	CE-marking	NorGeoSpec certification	Asqual certification	IVG certification
Legal character	Obligatory	Free	Free	Free
Management of the process	Notified body	Certification body	Certification body	Certification body
Technical committee including users	No	Yes	Yes	No
Round robin test between laboratories	No	(Yes)	Yes	No
Certification body	Yes	Yes	Yes	Yes
Accredited laboratory	No	Yes	Yes	Yes
Independence between producer and lab	No	Yes	Yes	No

Figure 3.3 Different national or regional QA systems compared to CE-marking

3.5 Fibertex Nonwovens Q-Match

In order to continuously monitor the geotextiles production to ensure consistently high quality levels in a practical and efficient way, Fibertex has developed a fully integrated quality control system called Q-Match.

Q-Match, as presented in Figure 3.4, is a digitally integrated quality management system implemented throughout the Fibertex Group. It is initiated at order registration. Throughout the entire production process, the system provides instant electronic control of product quality and process capability according to customer specifications. Q-Match contributes to improved and uniform quality while minimising errors and waste. Better for our customers – and for the environment.

Advantages include:

- 100% digital interaction between planning tool, ERP system (ERP = Enterprise resource planning), quality assurance and test database
- Raw material approval through electronic comparison with supplier specifications
- Automatic product surveillance through the continuous evaluation of test data against product specifications
- Calculation of statistical values during production
- Online visualisation of product characteristics by means of trend curves
- Only approved material can be scanned out for shipment

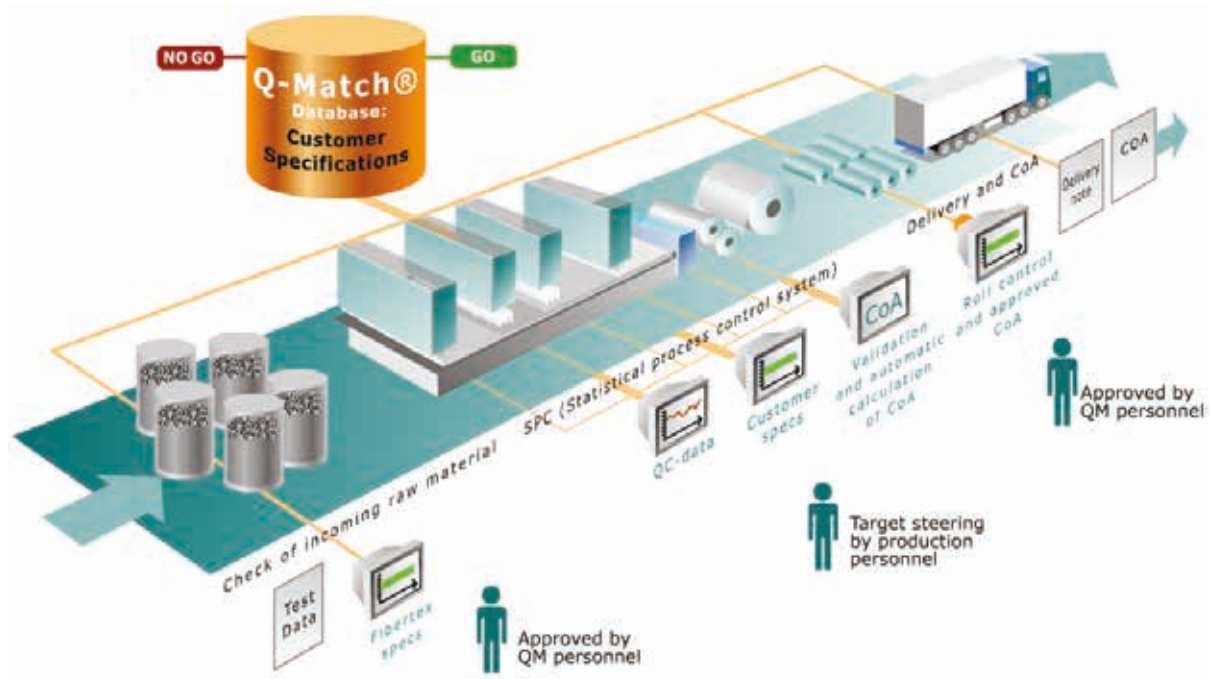

Figure 3.4 Q-Match – Fibertex's fully digitally integrated quality management system

4. Geotextile applications, functions and characteristics

4.1 Applications

Geotextiles are widely used in geotechnical and structural applications such as roads and railways, earth structures, drainage and filtration systems, hydraulic works and many other applications. To assist designers and users, several application standards have been established. One of the main goals of the European standardisation work is to establish harmonised standards that provide guidelines on how to specify the relevant characteristics of geotextiles and geotextile-related products when used in various applications. The list of harmonised application standards is presented in Figure 4.1.









	NF EN 13249	Construction of roads and other trafficked areas
	NF EN 13250	Construction of railways
	NF EN 13251	Earthworks, foundations and retaining walls
	NF EN 13252	Drainage systems
	NF EN 13253	Erosion control works
	NF EN 13254	Construction of reservoirs and dams
	NF EN 13255	Construction of canals
	NF EN 13256	Construction of tunnels and underground structures
	NF EN 13257	Solid waste disposals
	NF EN 13265	Liquid waste containment projects

Figure 4.1 European harmonised application standards for geosynthetics

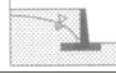
These standards cover the main geotextile applications. Fibertex Geotextiles are, thanks to their unique properties, used for many other applications both within the building industry as well as other industries, which are not described in standards, but still widely used. See www.fibertex.com for further information.

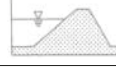
4.2 Functions

Depending on the different applications, the main functions of the geotextiles are “separation”, “filtration”, “drainage”, “protection” and “reinforcement”. In most applications, the geotextile covers a combination of several functions.

The functions are briefly defined as follows:

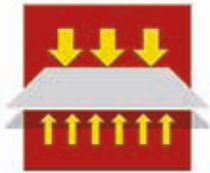

Separation

Separation is the basic use of geotextiles and is widely practised in roadworks and railway constructions.

In the EN ISO standards, the separation function is defined as **“The preventing from intermixing of adjacent dissimilar soils and/or fill materials by the use of a geotextile”**.

Benefits:

- Prevents mixing of the construction layers
- Increases bearing capacity by avoiding material loss into the subgrade
- Improves the compaction properties of the aggregate layer
- Provides long-term stability of foundation layers

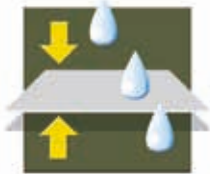

Filtration

Geotextiles are mainly used for filtration in drainage systems for road and railway constructions as well as coastal protection systems, rivers, canals, reservoirs and waste disposals.

In the EN ISO standards, the filtration function is defined as **“The restraining of soil or other particles subjected to hydrodynamic forces while allowing the passage of fluids into or across a geotextile”**.

Benefits:

- Prevents the migration of fine material into coarse material as a result of water flow in the soil
- Maintains the water flow in the soil with a minimum of pressure loss
- Prevents the migration of fine material as a result of pump effects from dynamic loads such as traffic



Drainage

Geotextiles are widely used for drainage in earth structures, construction works and environmental structures.

In the EN ISO standards, the drainage function is defined as **“The collecting and transporting of precipitation, groundwater and/or other fluids in the plane of the geotextile”**.

Benefits:

- Reduces the water level and reduces the opening pressure in the soil
- Geotextiles as a drainage element is a simple and well-defined solution
- Using geotextile drainage elements gives high drainage capacity per volume compared to traditional drainage gravel layers
- Ensures that water and/or other fluids are drained with a minimum of pressure loss
- Ensures lasting drainage

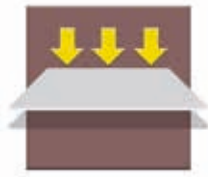

Protection

Geotextiles are widely used for protection in waste disposal lining systems and tunnel constructions to ensure the integrity of a sealing material (for example geomembrane) when fill material and/or loads are applied.

In the EN ISO standards, the protection function is defined as **“The prevention or limiting of local damage to a given element or material by the use of a geotextile”**.

Benefits:

- Gives high, durable protection to the waterproofing membrane
- Using protective geotextiles is a well-defined and reliable solution
- Easy to install compared to soil layers

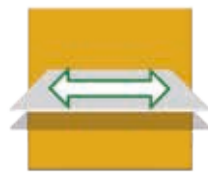

Reinforcement

Today, reinforcing typical structures such as retaining structures and embankments on soft soil is mainly performed using geogrids. Geotextiles are often used in combination with geogrids to ensure the separation and filtration functions. For minor reinforcement jobs, nonwoven Fibertex Geotextiles can be sufficient, but generally reinforcement calls for a more rigid material.

In the EN ISO standards, the reinforcement function is defined as **“The use of the stress-strain behaviour of a geotextile or a geotextile-related product to improve the mechanical properties of soil or other construction materials”**.

Benefits:

- A cost effective and safe solution for the reinforcement of retaining structures and embankments on soft soils
- Improves soil stabilisation and bearing capacity

4.3 Applications and main functions

Figure 4.2 below lists the main functions, depending on the different applications, based on the European standards.

Application	Main functions				
	Separation	Filtration	Drainage	Protection	Reinforcement
Roads	x	x			x
Railways	x	x			x
Earthworks	x	x			x
Drainage systems	x	x	x		
Erosion control	x	x			x
Reservoirs and dams	x	x		x	x
Canals	x	x		x	x
Tunnels and underground structures				x	
Solid waste disposals	x	x		x	x
Liquid waste containment	x	x		x	x

Figure 4.2 Relevant functions in different applications

To ensure that the geotextile can be used in the different functions and applications, the relevant characteristics of the geotextiles must be specified depending on the required soil conditions, hydraulic conditions and mechanical properties. Additionally, installation conditions and required durability must be evaluated in order to specify the corresponding required properties of the geotextile.

4.4 Characteristics

Figure 4.3 lists the relevant characteristics, depending on function. Together with Figure 4.2, “Relevant functions in different applications”, it describes the first steps in helping the designer to establish the required properties for the geotextiles to be used.

Characteristic	Method	Separation	Filtration	Drainage	Protection	Reinforcement
Tensile strength	NF EN ISO 10319	O	O	O	O	O
Elongation at break	NF EN ISO 10319	O	O	O	O	O
Static puncture (CBR test)	NF EN ISO 12236	O	O	O	O	O
Dynamic cone drop	NF EN ISO 13433	O	O	O	O	O
Abrasion	NF EN ISO 13427	S	S			S
Friction characteristics	NF EN ISO 12957	S	S	S	S	O
Tensile creep	NF EN ISO 13431					O
Compressive creep	NF EN ISO 25619				S	
Protection efficiency	NF EN 13719				O	
Pyramid puncture resistance	NF EN 14574				O	
Characteristic opening size	NF EN ISO 12956	O	O			
Water permeability normal to the plane	NF EN ISO 11058	O	O			
Water flow capacity in the plane	NF EN ISO 12958			O		
Weathering	NF EN 12224	O	O	S	O	O
Other durability, chemical and biological		S	S	S	S	S

Figure 4.3 Relevant characteristics depending on the functions required

O = Obligatory in all cases. (In the standards this is described as H = Required for harmonisation and A = Relevant for all conditions of use.)

S = Sometimes relevant depending on conditions of use.

4.5 Approach when designing with geotextiles

In the design process there are several aspects to be considered by the designer. In order to ensure that all relevant considerations are addressed, the flow diagram shown in Figure 4.4 can be used as a simple guideline, going through the different steps of the process.

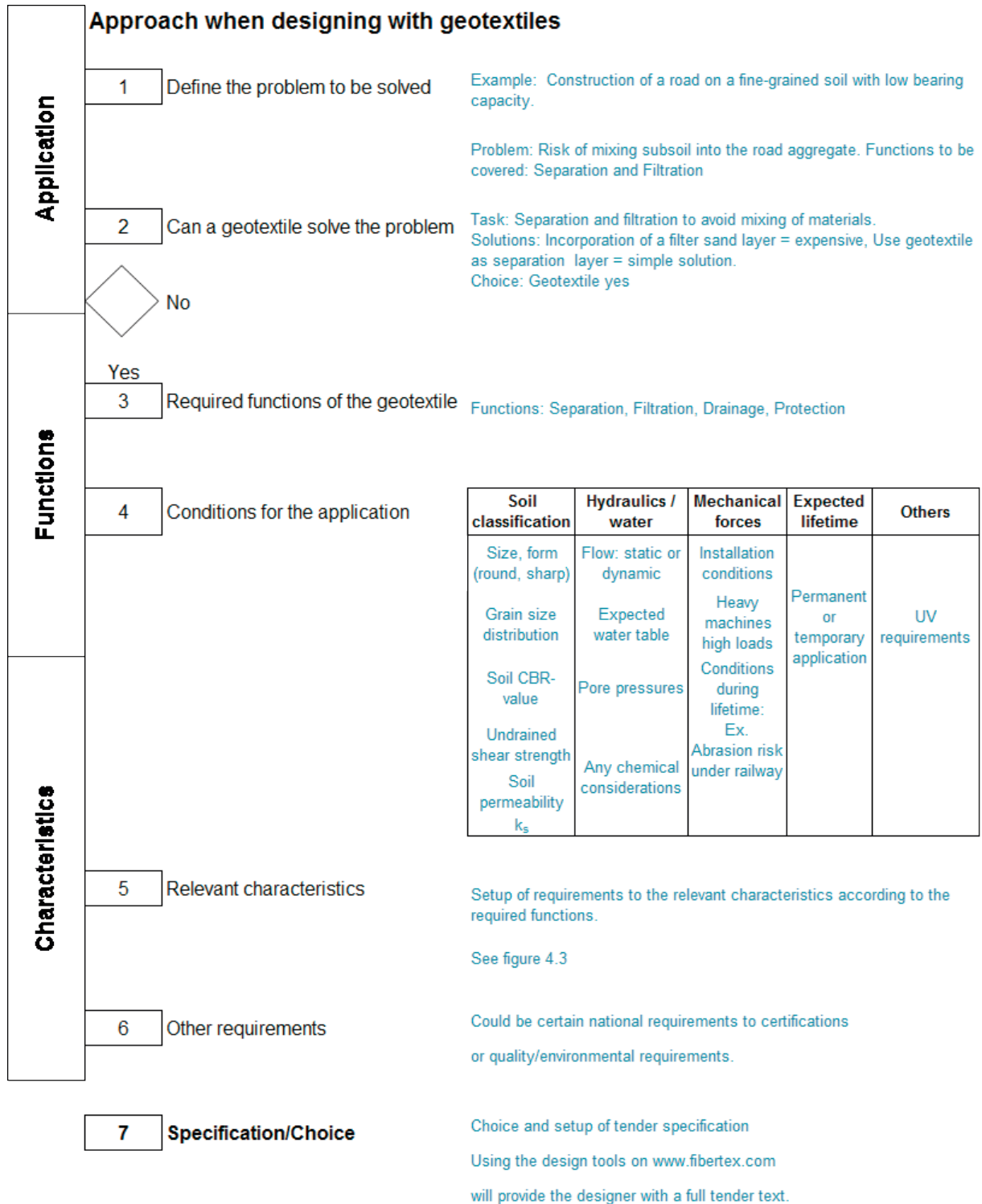

Figure 4.4 Approach when designing with geotextiles

More specific designs and characteristics depending on the required functions and applications are described in Chapter 5.

5. Functions of geotextiles – in detail

5.1 Background

For a given function, three types of characteristics, see Figure 5.1, need to be considered to carry out a full design:

- Functional characteristics
- Characteristics linked to resistance to damage during installation and lifetime
- Characteristics linked to the durability aspects of the geotextile

Function	Characteristics of the geotextile
1. Separation (soil-retention properties of the geotextile)	Characteristic opening size
2. Filtration (permeability through the geotextile)	Water permeability normal to the plane
3. Drainage (drainage capacity of the geotextile)	Water flow capacity in the plane
4. Protection (protection efficiency of the geotextile)	Protection efficiency, pyramid puncture resistance
Resistance to damage during installation and lifetime	Characteristics of the geotextile
5. Resistance to damage during installation and lifetime	Tensile strength and elongation, energy index, CBR strength etc.
Durability	Characteristics of the geotextile
6. Durability	Weathering resistance, expected lifetime, chemical resistance etc.

Figure 5.1 Three types of characteristics needed when designing using geotextiles

In the following sections, the relevant functional characteristics for each function are described in detail, whereas characteristics linked to resistance to damage during installation and lifetime and durability aspects are described in detail in Chapters 6 and 7, respectively.

5.2 Separation and filtration

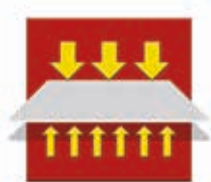

5.2.1 Separation

Separation is the basic use of geotextiles and is widely practised in infrastructure constructions.

In the EN ISO standards, the separation function is defined as **“The preventing from intermixing of adjacent dissimilar soils and/or fill materials by the use of a geotextile”**.

In Figure 5.2, the functional characteristic describing the function of separation is highlighted. The main functional characteristic is the characteristic opening size. The function “separation” is never specified alone, as considerations relating to hydraulic requirements should always be taken into consideration.



Function	Characteristics of the geotextile
1. Separation (soil retention properties of the geotextile)	Characteristic opening size

Figure 5.2 Separation characteristic of a geotextile

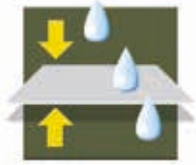

5.2.2 Filtration

Geotextiles are widely used for filtration in roadworks and railway constructions as well as coastal protection.

In the EN ISO standards, the filtration function is defined as **“The restraining of soil or other particles subjected to hydrodynamic forces while allowing the passage of fluids into or across a geotextile”**.

The characteristic opening size of geotextiles is mainly designed to retain particles while allowing free movement of water, making it possible to separate two layers during hydraulic activity. Migration of layers, which would reduce the load-bearing capacity of the construction, is thereby avoided and, at the same time, water flow is maintained with minimum pressure loss.



Figure 5.3 lists the functional characteristics describing the functions filtration and separation. The main functional characteristic is the characteristic opening size and the water permeability normal to the plane.

Function	Characteristics of the geotextile
1. Separation (soil retention properties of the geotextile)	Characteristic opening size
2. Filtration (permeability through the geotextile)	Water permeability normal to the plane

Figure 5.3 Filtration and separation characteristics of a geotextile

There are many different theories covering this topic. Various authors have described their own design rules in relation to characteristic particle sizes of the subsoil and characteristic values allocated to the geotextiles. In the following, the main principles are stated, and a summary of the filtration criteria determined by the most internationally well-known experts.

Natural filter/bridging

The opening size of an efficient geotextile should be small enough to retain larger soil particles to prevent soil erosion. It is generally accepted that a certain percentage of the soil particles is smaller than the largest size of openings in the geotextile, and that there will be a loss of the smallest soil particles. However, this will stop after a period of time due to the formation of a natural filter. A natural filter is a granular layer from which the finer particles are washed out and therefore the remaining coarser fraction will act as a filter medium for the subsoil. This is also described as a bridging network of particles.

The geotextile functions as a catalyst: It promotes equilibrium between particles after the limited washout of finer particles by inducing a self-filtration zone (bridging) at the interface.

The functional requirements of a geotextile filter can be expressed as follows:

- To allow fine free soil particles to pass through the geotextile
- To keep a stable soil structure by building up a natural filter
- To maintain sufficient permeability in the geotextile throughout the lifetime of the application

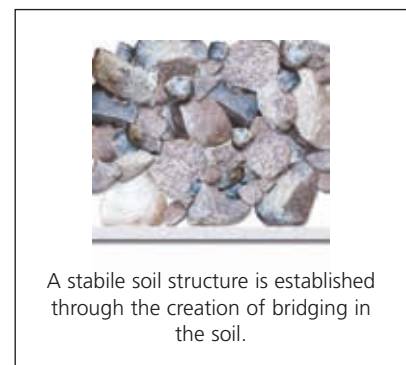
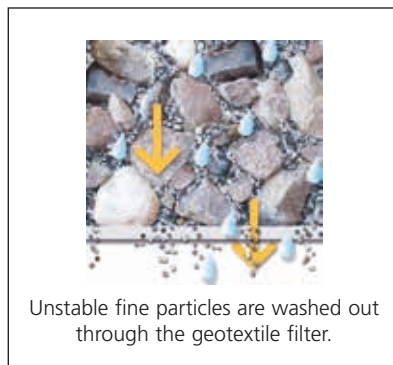
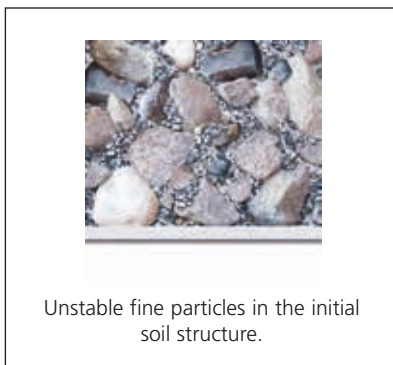

5.2.3 Designing a geotextile filter

When deciding on the full design of a geotextile filter, all the characteristics in Figure 5.4 must be considered.

Function	Characteristics of the geotextile
1. Separation (soil retention properties of the geotextile)	Characteristic opening size
2. Filtration (permeability through the geotextile)	Water permeability normal to the plane
Resistance to damage during installation and lifetime	Characteristics of the geotextile
5. Resistance to damage during installation and lifetime	Tensile strength and elongation, energy index, CBR strength etc.
Durability	Characteristics of the geotextile
6. Durability	Weathering resistance, expected lifetime, chemical resistance etc.

Figure 5.4 Filter characteristics of a geotextile

1. and 2. relate to the specific filter design. 5. and 6. relate to the specific application and more to installation and service conditions, together with the expected lifetime of the product. In the following, the hydraulic design is described, whereas durability aspects are described in Chapter 7, and resistance to damage during installation and lifetime is described in Chapter 6.

Depending on the soil and the hydraulic conditions, the following design criteria can be used.

Required hydraulic properties

For optimal function, the characteristic opening size of the geotextile has to match the soil conditions. If the characteristic opening size is too large, the soil particles will pass through the geotextile, whereas if the permeability of the geotextile it is too small, the water flow through the product will be insufficient.

The water flow to be considered can be divided into static and dynamic flows:

- Static (one-way) water flow: e.g. drains and traditional structural dewatering systems
- Dynamic water flow: e.g. horizontal filters under e.g. rail track beds, hydraulic and coastal protection constructions

The important hydraulic parameters of the geotextile are:

1. **O_{90%}** Characteristic opening size [μm], according to EN ISO 12956
2. **V_{H50}** Velocity Index expressing the permeability through the geotextile [m/sec], according to EN ISO 11058.

Characteristic opening size, O_{90%}

O_{90%} is the characteristic opening size of a geotextile, and is expressed in μm (micron), and basically tells us about the grain sizes able to pass the geotextile. It is measured by wet sieving a predefined test grain mixture, and **d_{90%}** of the material passing through the geotextile = **O_{90%}** .

The principles of the test are set out in Figure 5.5, which also shows an example of how to read the opening size from the grain size distribution curve.

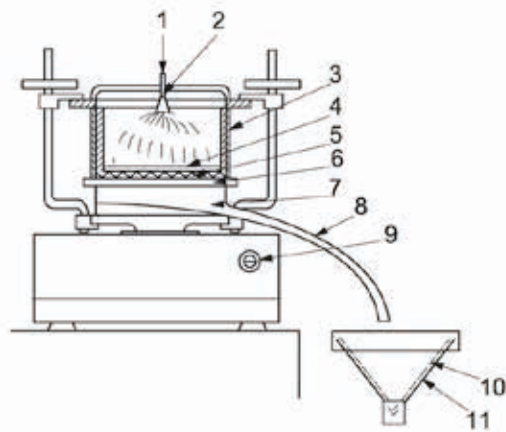

- Key
- 1 water supply
 - 2 spray nozzle(s)
 - 3 clamping device
 - 4 granular material
 - 5 specimen
 - 6 support grid
 - 7 pan
 - 8 connecting tube
 - 9 amplitude regulator
 - 10 filter paper
 - 11 collection device

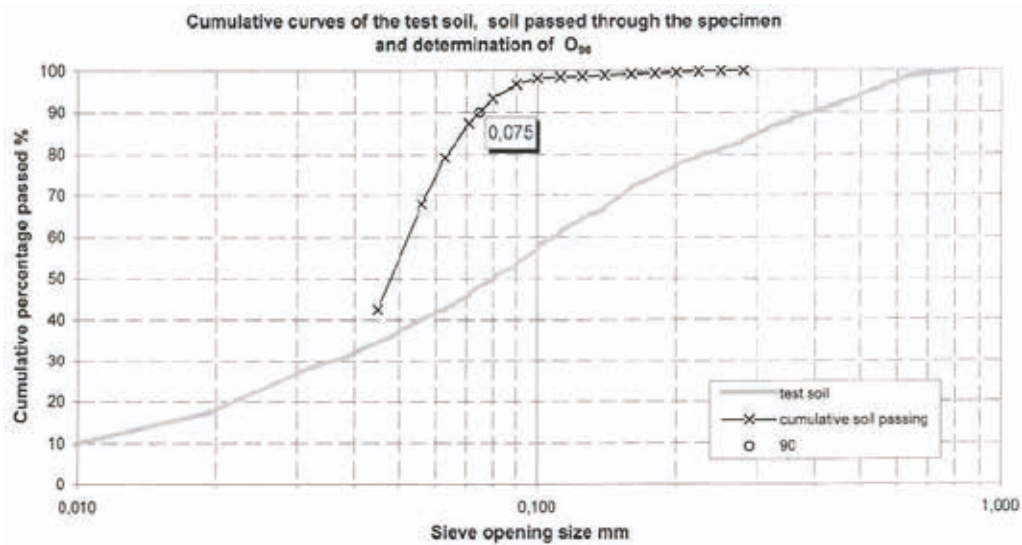

Figure 5.5 Principal set-up of test of opening size to EN ISO 12956 /EN ISO 12956

Based on soil classifications and hydraulic conditions, requirements listed in Figure 5.6 can be used:

	Slow waterflow: Trenches, storage areas etc.	Bidirectional flow or dynamic loads
Soil classification	Opening size $O_{90\%}$ according to EN ISO 12956 (μm)	
Silt	To be evaluated	To be evaluated
Clay, fine clay	63 - 200	63 - 100
Clayey sands (granularity $U < 5$)	63 - 150	63 - 100
Clayey sands (granularity $U > 5$)	63 - 300	63 - 180
Sand (granularity $U < 5$)	63 - 150	63 - 100
Sand (granularity $U > 5$)	63 - 300	63 - 180
Gravel	63 - 500	63 - 300

Figure 5.6 Requirement to opening size of geotextile depending on soil classification. /Extracted from NF G 38-061/

Designing with geotextiles with opening sizes ranging from 63 -100 μm makes it possible to cover most situations involving both static and dynamic hydraulic flows.

When using geotextiles in silty soils, it can be difficult to establish a natural filter. In these situations it can be advantageous to incorporate a thin layer of filter sand in between the soil and the geotextile, as this also increases the speed of the flow.

Permeability and Velocity Index of the geotextile

It is obvious that the permeability of the geotextile should be higher than the permeability of the soil. The coefficient of permeability normal to the plane of the geotextile must be greater than the permeability of the soil, including a factor of safety, FOS:

$$k_{\text{geotextile}} > \text{FOS} \cdot k_{\text{soil}} \quad \text{where,}$$

$k_{\text{geotextile}}$ is the coefficient of permeability of the geotextile
 k_{soil} is the coefficient of permeability of the soil
 FOS is a factor of safety

The permeability of geotextiles is normally expressed by the velocity index V_{H50} measured according to EN ISO 11058 using a hydraulic head of 50 mm. The principle of the test is set out in Figure 5.7.

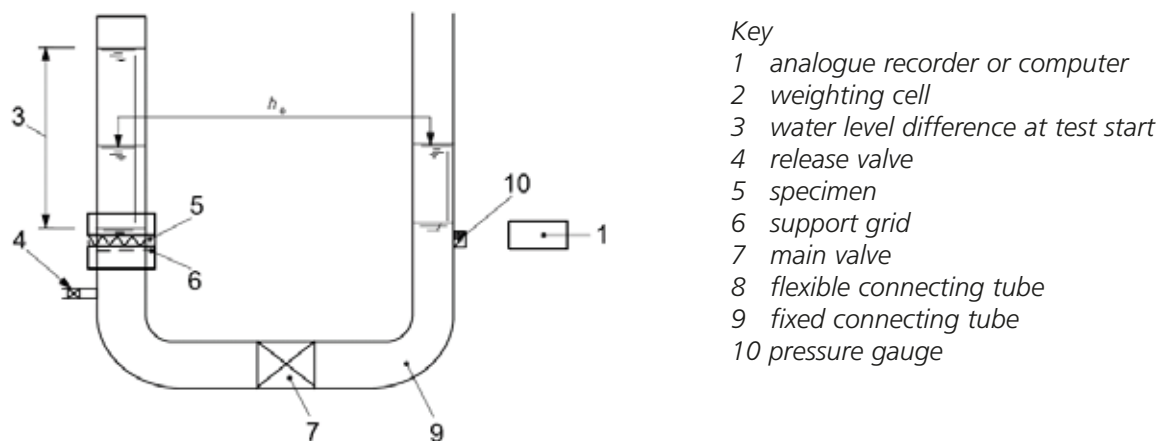

Figure 5.7 Principal set-up of Velocity Index test to EN ISO 11058 using the falling head method. /EN ISO 11058/

Using Darcy's law, the permeability criteria can be expressed as follows:

$$V_{H50, \text{geotextile}} > \text{FOS} \cdot k_{\text{soil}} \cdot i_{\text{soil}} \quad \text{where,}$$

$V_{H50, \text{geotextile}}$ is the measured velocity index on the geotextile
 k_{soil} is the coefficient of permeability of the soil
 i_{soil} is the hydraulic gradient in the soil
 FOS is a safety factor covering uncertainties relating to:

- level of hydraulic head
- type of structure
- hydraulic situation
- reduction of permeability during lifetime, e.g. caused by mechanical and chemical clogging

From the literature, values for FOS are between 1 and 1000 and can be very difficult to set. /NG G 38-184 and John Bowders 2002, "Training on drainage and filters", 7th ICG, Nice 2002/.

Figure 5.8 lists the typical gradients in civil engineering applications.

Application	Typical hydraulic gradient i_{soil}
Standard dewatering trench	1
Vertical wall drain	1,5
Pavement edge drain	1
Landfill leachate collection removal system	1,5
Landfill closure surface water collection removal system	1,5
Dam toe drain	2
Dam clay cores	3 -> 10
Inland channel protection	1
Shoreline protection	10

Figure 5.8: Typical hydraulic gradients in civil engineering /Giroud J.P., 1996. Granular filters and geotextile filters in civil engineering

In practice, a relation between the type of soil (level of permeability) and a suggested required level of velocity index V_{H50} can be used. This relation is outlined in Figure 5.9.

Soil classification	Permeability	Typical required min. velocity index V_{H50}
Silt	Low permeable soil $k = 10^{-5}-10^{-6}$ m/s	$5 \cdot 10^{-3}$ m/s
Clay, fine clay	Very low permeable soil $k = 10^{-6}-10^{-13}$ m/s	$0.5 \cdot 10^{-3}$ m/s
Clayey sands (granularity $U < 5$)	Very low permeable soil $k = 10^{-6}-10^{-13}$ m/s	$0.5 \cdot 10^{-3}$ m/s
Clayey sands (granularity $U > 5$)	Very low permeable soil $k = 10^{-6}-10^{-13}$ m/s	$0.5 \cdot 10^{-3}$ m/s
Sand (granularity $U < 5$)	Permeable soil $k = 10^{-4}-10^{-5}$ m/s	$10 \cdot 10^{-3}$ m/s
Sand (granularity $U > 5$)	Permeable soil $k = 10^{-4}-10^{-5}$ m/s	$10 \cdot 10^{-3}$ m/s
Gravel	Very permeable soil $k = 10^{-2}-10^{-4}$ m/s	$30 \cdot 10^{-3}$ m/s

Figure 5.9 Typical required Velocity Index of the geotextile depending on soil classification

Using these levels is equivalent to a factor of safety (FOS) in very permeable soils in the range of 10, while for low permeable soils which contain finer materials the safety factor is in the range of 500, depending on the actual hydraulic gradient.

In choosing the right FOS, it is, of course, also necessary to consider the type of structure and accompanying risk level.

5.2.4 Example – drainage trench

A traditional drainage trench, see Figure 5.10, is to be designed using the appropriate geotextile relating to filtration and separation properties.

A sieving analysis has been conducted on the surrounding soil, with results as shown in Figure 5.11.

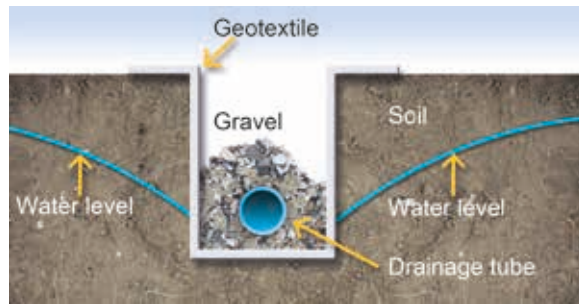

Figure 5.10: Drainage trench installation

The soil is a sand with granularity $U = d_{60}/d_{10} = 1.2/0.1 = 12$ ie. > 5 .

From Figure 5.9, the min. V_{H50} according to EN ISO 11058 is found to be:
 Min. $V_{H50} = 10 \cdot 10^{-3}$ m/s

From Figure 5.6, the opening size $O_{90\%}$ according to EN ISO 12956 is found to be:
 Opening size $O_{90\%} = 63 - 300$ μm .

A full design must include requirements regarding resistance to damage during installation and lifetime and durability properties; see Chapters 6 and 7.

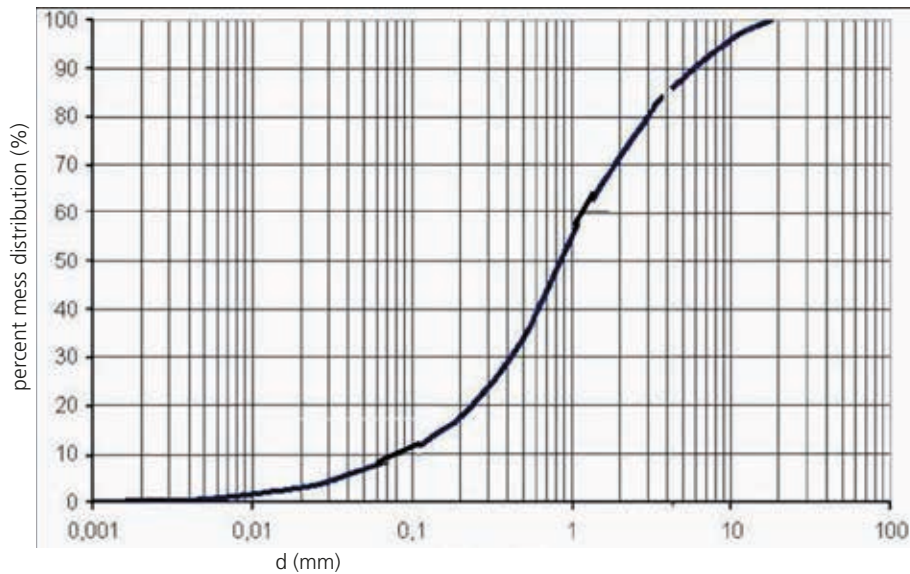

Figure 5.11 Grain size curve for soil to be filtered

5.2.5 Example – hydraulic structure

A coastal protection using armour rock and a geotextile for separation and filtration is to be installed as shown in the figure below.

The geotextile is used as a filtration and separation element between the armour rock, weighing up to 400 kg, and the subsoil, which consists of clayey sand with a granularity of $U = d_{60}/d_{10} < 5$.

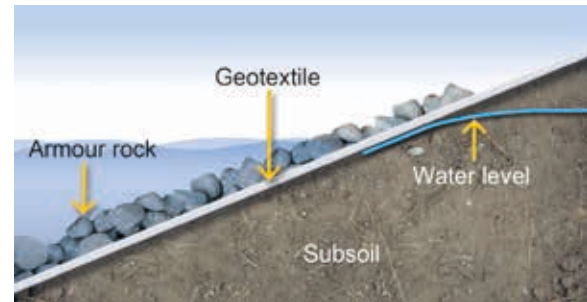

Figure 5.12 Coastal protection structure using armour rock and geotextile

From Figure 5.9, the min. V_{H50} according to EN ISO 11058 is found to be:

$$\text{Min } V_{H50} = 0.5 \cdot 10^{-3} \text{ m/s}$$

From Figure 5.6, the opening size $O_{90\%}$ according to EN ISO 12956 is found to be:

$$\text{Opening size } O_{90\%} = 63 - 100 \text{ } \mu\text{m}.$$

A full design must include requirements regarding resistance to damage during installation and lifetime and durability properties; see Chapters 6 and 7.

5.2.6 Fibertex design approach

Due to different national specifications, quality certifications and design guidelines, the grades and characteristics required may be different in the different countries. In this case, these requirements supersede the requirements calculated using methods from this note.

To establish full design specifications, including requirements in terms of resistance to damage during installation and lifetime and durability properties, the calculation tool at www.fibertex.com can be used.

5.3 Drainage



5.3.1 Drainage capacity of a geotextile

Geotextiles are widely used for drainage in earth and construction works.

In the EN ISO standards, the drainage function is defined as **“The collecting and transporting of precipitation, groundwater and/or other fluids in the plane of the geotextile”**.



Characteristics describing the function of a drainage element:

Function	Characteristics of the geotextile
3. Drainage (Drainage capacity in the geotextile)	Water flow capacity in the plane

Figure 5.13 Drainage characteristic of a geotextile

Together with the drainage function, the filtration and separation functions are normally also required in order to be able to collect the water from the surrounding soil.

Water flow capacity in the plane of the geotextile $q_{\text{geotextile}}$

The water flow capacity of the geotextile is measured according to EN ISO 12958, see Figure 5.14. The measurements are made at different hydraulic gradients and using different levels of normal compressive stresses.

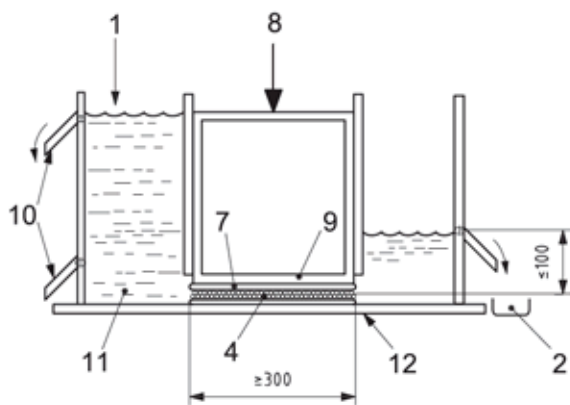

- Key
- 1 water supply
 - 2 water collection
 - 3 manometers
 - 4 specimen
 - 5 membrane
 - 6 pressure cell
 - 7 foam
 - 8 load
 - 9 loading platen
 - 10 overflow weirs at hydraulic gradients 0.1 and 1.0
 - 11 water reservoir
 - 12 base

Figure 5.14 Principal set-up of test water flow capacity in the plane to EN ISO 12958./EN ISO 12958/

5.3.2 Designing a geotextile drainage element

When deciding on the full design of geotextile drainage element, the following aspects must be considered:

Function	Characteristics of the geotextile
1. Separation (soil retention properties of the geotextile)	Characteristic opening size
2. Filtration (permeability through the geotextile)	Water permeability normal to the plane
3. Drainage (drainage capacity in the geotextile)	Water flow capacity in the plane
Resistance to damage during installation and lifetime	Characteristics of the geotextile
5. Resistance to damage during installation and lifetime	Tensile strength and elongation, energy index, CBR strength etc.
Durability	Characteristics of the geotextile
6. Durability	Weathering resistance, expected lifetime, chemical resistance etc.

Figure 5.15 Drainage and filter characteristics of a geotextile

1. and 2. relate to the filter design whereas 5. and 6. relate to the specific application, referring more to installation and service conditions, together with the expected lifetime of the product. Below, the drainage design, 3. Drainage capacity is described, whereas durability aspects are described in Chapter 7, while resistance to damage during installation and lifetime are described in Chapter 6.

Required water flow capacity per unit width, q_{design}

The required in-plane water flow capacity is calculated on the basis of the amount of water to be drained. The in-plane water flow capacity is expressed as the amount of drained water within a given time in a given width of the geotextile.

The necessary in-plane water flow capacity q_{design} , can be found as:

$$q_{design} = \frac{Q}{l \cdot i} = \Theta \cdot i$$

Where:

Q = amount of water to be drained in the full width of the drain [m^3/sec]

W = width of the drain [m]

i = hydraulic gradient (h/l) = $\sin \beta$ see Figure 5.16.

Where $i=1$ for vertical drains.

Θ = Transmissivity [m^2/s]

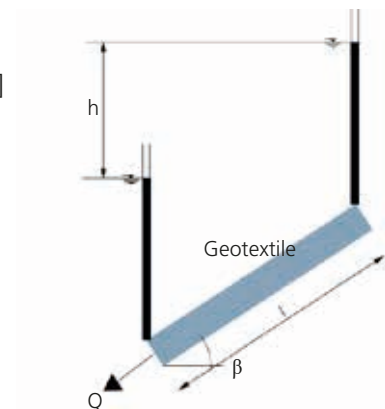

Figure 5.16 Calculation of the hydraulic gradient for inclined drains

The general design criteria can be expressed as

$$q_{\text{geotextile}} > \text{FOS} \cdot q_{\text{design}}$$

FOS is a safety factor covering uncertainties relating to:

- Reduction of in-plane water capacity during lifetime, for example caused by chemical and biological clogging
- Local deformations
- Reduction of in-plane water capacity during lifetime, for example caused by compressive creep

Part of choosing the right FOS also includes, of course, considerations relating to the type of structure and the accompanying risk level.

From the literature, a typical value for FOS is between 1 and 10 and can be rather difficult to set. /John Bowders 2002, "Training on drainage and filters", 7th ICG, Nice 2002/.

5.3.3 Example – drainage on a roof garden

The principle scheme of the structure is shown in Figure 5.17, showing a slope on a roof garden.

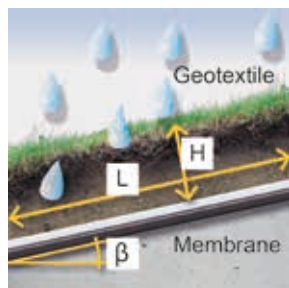

Figure 5.17 Drainage on a slope on a roof garden

Key

- L length of slope
- H height of top soil
- γ volume weight of top soil
- q_{rain} rainfall water flow
- β slope angle of the drainage geotextile

Design the geotextile versus the drainage function for the following data:

- $L = 10 \text{ m}$
- $H = 1.0 \text{ m}$
- $\gamma = 19 \text{ kN/m}^3$
- $q_{\text{rain}} = 1 \text{ l/m}^2 \text{ h}$
- $i = 0.01, \beta = 0.6$

Normal compressive stress on the geotextile:
 $\sigma_n = 1.0 \text{ m} \cdot 19 \text{ kN/m}^3 \cos^2 0.6 = 19 \text{ kPa}$

Water flow to be drained:
 $q_{\text{design}} = q_{\text{rain}} \cdot L \cos \beta = 1 \text{ l/m}^2 \text{ h} \cdot 10 \text{ m} \cos 0.6 = 10 \text{ l/m h}$

Minimum requirement to the geotextile, assuming a factor of safety (FOS) of 5 as being representative for the application:

$q_{\text{geotextile}}(\sigma_n, i) = q_{\text{geotextile}}(19 \text{ kPa}, 0.01) = 5 \cdot 10 \text{ l/m h} = 50 \text{ l/m h}$ at a normal compressive stress of min 19 kPa and at a gradient of 0.01.

For permanent drainage structures, an evaluation of the compressive creep of the drainage element should also be included.

5.3.4 Fibertex design approach

Due to different national specifications, quality certifications and design guidelines, the grades and characteristics required may be different in the different countries. In that case, these requirements supersede the requirements calculated using methods from this note.

To establish full design specifications, including requirements in terms of resistance to damage during installation and lifetime and durability properties, the calculation tool at www.fibertex.com can be used.

5.4 Protection

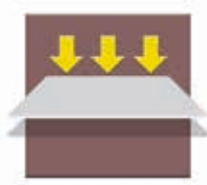

5.4.1 Protection

Geotextiles are widely used for protection in waste disposal systems, tunnel constructions and other deep ground structures to ensure the integrity of the sealing structure (e.g. geomembrane) when fill material and/or loads are applied. Using geotextiles has also proven its value for protecting membranes used in artificial lakes and water reservoirs.

In the EN ISO standards, the protection function is defined as **“The prevention or limiting of local damage to a given element or material by the use of a geotextile”**.



In Figure 5.18, the characteristics describing the function “protection” are listed. The main functional characteristics are protection efficiency and pyramid puncture resistance.

Function	Characteristics of the geotextile
4. Protection (protection efficiency of the geotextile)	Protection efficiency, pyramid puncture resistance

Figure 5.18 Protection efficiency characteristics of a geotextile

5.4.2 Designing a geotextile for protection

When deciding on the full design of a geotextile protection element, the following aspects must be considered.

Function	Characteristics of the geotextile
4. Protection (protection efficiency of the geotextile)	Protection efficiency, pyramid puncture resistance
Resistance to damage during installation and lifetime	Characteristics of the geotextile
5. Resistance to damage during installation and lifetime	Tensile strength and elongation, energy index, CBR strength etc.
Durability	Characteristics of the geotextile
6. Durability	Weathering resistance, expected lifetime, chemical resistance etc.

Figure 5.19 Characteristics of a geotextile designed for the function “protection”

4. relates directly to the protection capacity of the product. 5. and 6. relate to the specific application and more to installation and service conditions, together with the expected lifetime of the product. The hydraulic characteristics of the geotextile are often of importance. Design relating to filtration and separation is found in Section 5.1, while design relating to drainage is found in Section 5.2.

This means that for the function “protection”, the mechanical properties are essential. The geotextile must withstand and distribute any local pressure from the layer above, ensuring that the protected material is not stressed to failure.

Several field studies and cases have been carried out over the years to investigate which characteristics of the geotextile are the most important for protection of the liner. Different approaches are used, and they are often based on empirical know-how. The following mechanical properties of a protection geotextile are currently regarded as some of the most important characteristics:

- Tensile strength and elongation at break, expressed as Energy Index [kJ/m]. Based on EN ISO 10319.
- Static puncture resistance (CBR-test) [N]. According to EN ISO 12236
- Dynamic perforation (cone drop test) [mm]. According to EN ISO 13433

Nevertheless two “protection” characteristics have been defined in the harmonised standards to characterise the functional characteristics. This avoids the use of thickness or the mass per unit area in the specification, which are very poorly related to the real protection efficiency. For large landfill projects, the protection efficiency is often evaluated, by testing the geotextile together with the specific geomembrane to be used.

- Protection efficiency at different loads [%]. According to EN 13719
- Pyramid puncture resistance [N]. According to EN 14574

Protection efficiency to EN 13719

This test method, as set out in Figure 5.20, evaluates the ability of the geotextile to protect the geomembrane. The deformations on a plate of lead placed under the geotextile, which is loaded using simulated standard aggregate and different loads are measured, and the protection efficiency of the geotextile is calculated from the level of deformations.

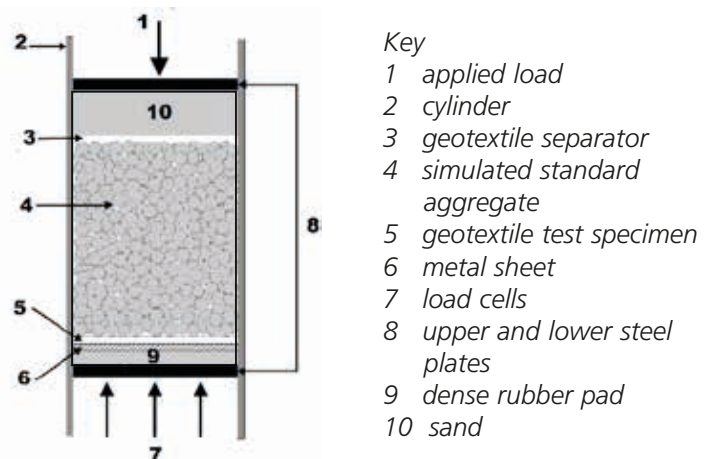

Figure 5.20 Principal set-up of the protection efficiency test to EN13719. IEN 13719/

Pyramid puncture resistance to EN 14574

A test specimen lies flat on an aluminium plate supported by a steel base, secured in a tensile/compression testing machine. A force is exerted on the centre of the test specimen by an inverted steel pyramid, attached to a load indicator, until perforation of the specimen occurs. The recorded push-through load is considered to be representative for the protection efficiency of the specimen. The test method is shown in Figure 5.21.

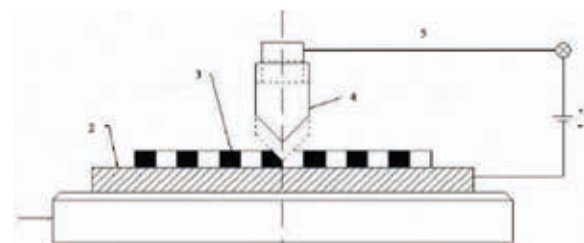

Figure 5.21 Principal set-up of the pyramid puncture resistance test to EN 14574

Using the characteristics listed in Figure 5.19, the main characteristics for geotextiles for protection can be established, adding a number of correction factors depending on the conditions of use and installation:

$$Char_{req} = Char_{basis} \cdot \prod_1^X CF_x \quad , \text{ where}$$

Char_{basis} = Basic requirement set-up for geotextiles used for protection (represents the minimum requirements to the product when installed)

CF_x = Correction factor relevant for the specific application and installation

For geotextiles with the function of protection, the following basic requirements are set out, see Figure 5.22:

			Basic requirements
Average tensile strength	NF EN ISO 10319	(kN/m)	20
Average elongation at maximum load	NF EN ISO 10319	(%)	min 50%
Energy Index	NF EN ISO 10319	(kN/m)	5.0
Static puncture (CBR test)	NF EN ISO 12236	(N)	2500
Dynamic cone drop	NF EN ISO 13433	(mm)	20
Protection efficiency	NF EN 13719	(%)	4
Pyramid puncture resistance	NF EN 13474	(N)	200

Figure 5.22 Basic requirements to a geotextile for protection

The correction factors are regarded to be functions of:

CF (Size of contact material, shape of contact material, level of pressure from overlay)

With the factors as listed.

CF₁ = Factor for particle size of the contact material.

Corr. factor CF ₁	Contact material d _{max} (mm)
1	d _{max} ≤ 8 mm
1.2 (0.83)	d _{max} ≤ 16 mm
1.4 (0.71)	d _{max} ≤ 32 mm

CF₂ = Factor for the shape of the contact material.

Corr. factor CF ₂	Contact material (-)
1	Rounded
1.5 (0.67)	Course

CF₃ = Factor for the normal pressure on the protective structure.

Corr. factor CF ₃	Pressure from overlay σ (kN/m ²)
1	σ ≤ 100
1.3 (0.77)	100 < σ ≤ 250
1.6 (0.625)	250 < σ ≤ 400

Values in () are to be used for characteristics where a max. value is required: dynamic cone drop, protection efficiency.

5.4.3 Fibertex design approach

By using this method, a common and well-defined method is established. The applied correction factors are regarded as being the most important parameters which influence the product requirements. As the type of membrane is not known or specified, the quality of the used membrane should be taken into account, including any specific requirements set out by the supplier of the geomembrane.

It should be noted that the approach is to be regarded as a guideline applicable for typical installations. A detailed evaluation will require further knowledge of the specific properties of the membrane being used and the acceptable levels of deformations during the expected lifetime.

Due to requirements specified by the supplier of the membranes and due to different national specifications, quality certifications and design guidelines, the grades and characteristics required may be different to the requirements calculated using this note. In which case these requirements supersede the requirements calculated using methods from this note.

5.4.4 Example – geotextile for protecting membrane in a waste disposal facility

A geotextile for protecting an HDPE membrane at the bottom of a potentially 20 m deep waste disposal area needs to be designed. Above the protective geotextile is a drainage layer with rounded drainage stones with diameters of up to 16 mm. The density of the waste is $\gamma = 11 \text{ kN/m}^3$.

The soil below the membrane is fine clayey rounded sand with $d_{\text{max}} < 4 \text{ mm}$.

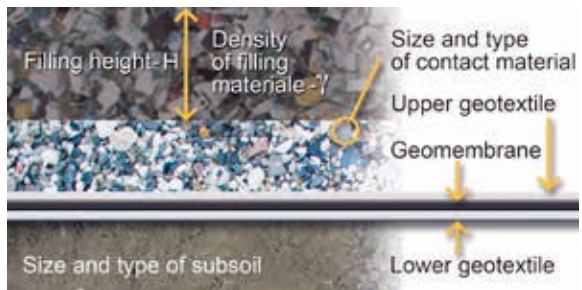

Figure 5.23 Geotextile used for protection in a waste disposal facility

Geotextile on top of membrane:

$$Char_{req} = Char_{basis} \cdot CF_1 \cdot CF_2 \cdot CF_3 = Char_{basis} \cdot 1.2 \cdot 1.0 \cdot 1.3 = Char_{basis} \cdot 1.56$$

Giving:

			Basic requirements	With CF = 1.56 (0.64)
Average tensile strength	NF EN ISO 10319	(kN/m)	20	31.2
Average elongation at maximum load	NF EN ISO 10319	(%)	min 50%	min 50%
Energy Index	NF EN ISO 10319	(kJ/m)	5.0	7.8
Static puncture (CBR test)	NF EN ISO 12236	(N)	2500	3900
Dynamic cone drop	NF EN ISO 13433	(mm)	20	13
Protection efficiency	NF EN 13719	(%)	4	2.6
Pyramid puncture resistance	NF EN 13474	(N)	200	312

Geotextile below membrane:

$$Char_{req} = Char_{basis} \cdot CF_1 \cdot CF_2 \cdot CF_3 = Char_{basis} \cdot 1.0 \cdot 1.0 \cdot 1.3 = Char_{basis} \cdot 1.3$$

Giving:

			Basic requirements	With CF = 1.3 (0.77)
Average tensile strength	NF EN ISO 10319	(kN/m)	20	26
Average elongation at maximum load	NF EN ISO 10319	(%)	min 50%	min 50%
Energy Index	NF EN ISO 10319	(kJ/m)	5.0	6.5
Static puncture (CBR test)	NF EN ISO 12236	(N)	2500	3250
Dynamic cone drop	NF EN ISO 13433	(mm)	20	15
Protection efficiency	NF EN 13719	(%)	4	3.1
Pyramid puncture resistance	NF EN 13474	(N)	200	260

6. Damage during installation and required mechanical strength during lifetime

6.1 Background

The damage resistance of the product is a very important part of the design. This is relevant not only when the geotextile has been installed and covers its functions during the design life, but also during installation where the requirements to the mechanical properties are often higher than the properties required after installation.

The functional properties, available compared to required as a function of time is indicated in Figure 6.1.

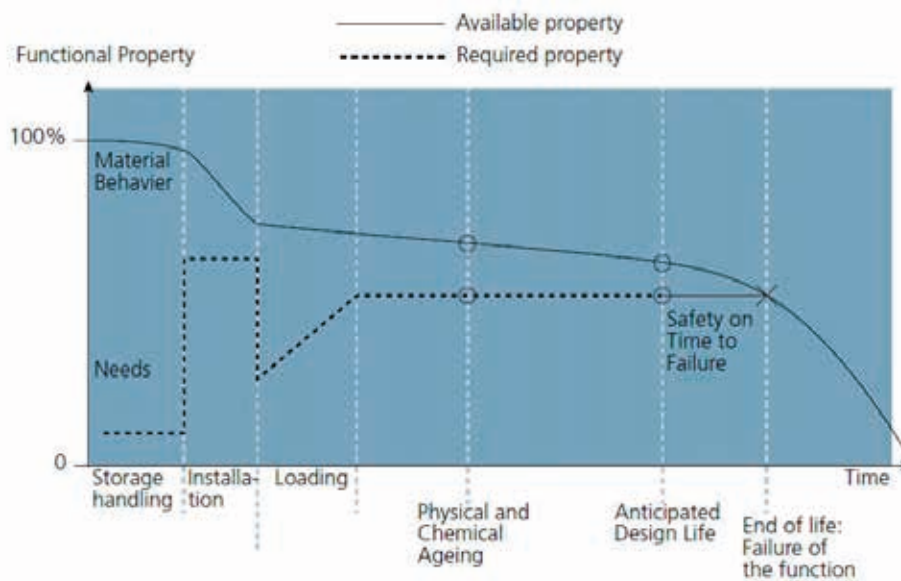

Figure 6.1 Typical available and required values of a functional property as a function of time IEN 13434/

Figure 6.1 is a schematic representation of the evolution of the available property of a material as a function of time, as represented by the upper curve on the graph. The functional property may be a mechanical property such as tensile strength or a hydraulic property such as permeability. The events that happen between product manufacture and the end of product life are indicated along the time axis. The lower curve represents the changes in the required property during these different and successive events. The shape of the curve relates to mechanical strength, but would not be very different for a hydraulic property.

A geotextile covers one or more functions – a damaged geotextile will not perform any function. Generally, the most critical phases in the life of a geotextile are installation and construction rather than its service life, see Figure 6.1.



Figure 6.2 Examples of installations requiring high energy absorption by the geotextile

6.2 Energy Index (based on tensile test according to EN ISO 10319)

Using the energy absorption potential of a geotextile is being increasingly recognised as one of the main characteristics in describing a geotextile’s damage resistance. Research from several independent institutes demonstrates that there is a significantly better correlation between the resistance of a geotextile to the installation stresses and its energy absorption potential when compared to typical characteristics such as tensile strength and static puncture resistance.

A geotextile has a certain energy absorption potential. For geotextiles, the energy absorption is defined as the area under the stress-strain curve for tensile strength (Figure 6.3) when tested according to EN ISO 10319. The Energy Index (kJ/m² or kN/m) expresses the maximum energy a geotextile can absorb at maximum strength.

For practical purposes, a simplified model for the energy index as described in Figure 6.3 is used, independently of the specific shape of the stress-strain curve.

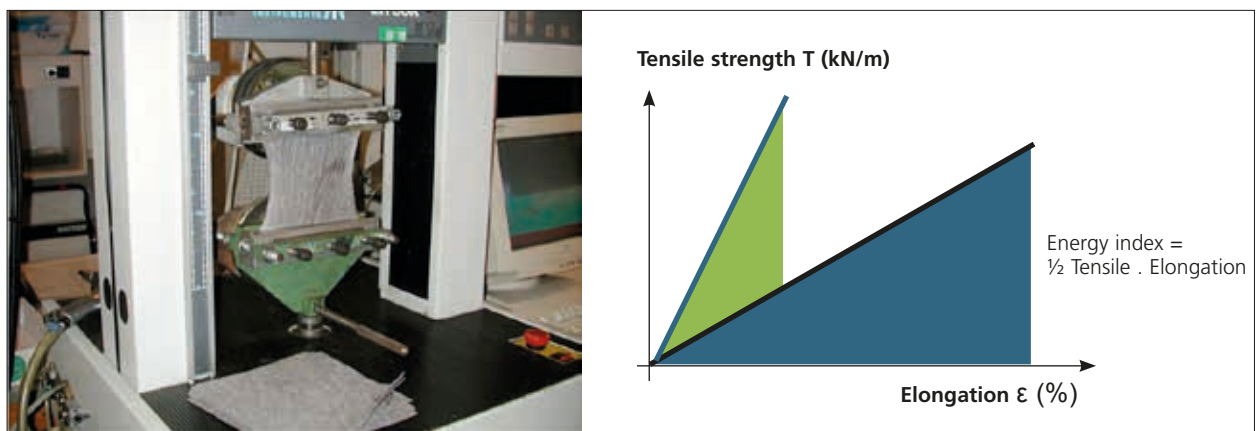

Figure 6.3 A stiff geotextile needs more tensile strength than a geotextile with higher elongation to achieve the same Energy Index

6.3 Static puncture resistance (EN ISO 12236)

The static puncture resistance (CBR elongation and strength) is also used to specify requirements to the geotextile. It is mainly used to give an indication of the risk of local damage to the geotextiles due to dropping or the penetration of stones and rocks.



Figure 6.4 Static puncture resistance (CBR test) compared to real-life installations

In the European application standards, information regarding the tensile strength and elongation according to EN ISO 10319, and the static puncture resistance according to EN 12236 are required for specification purposes.

6.4 Theoretical model

Several articles and test reports have been published over the years. Until now it has not been possible to set up a full theoretical model which covers all installations and variations, which are:

- Base soil and its geotechnical parameters
- Filling material, size, weight and shape
- Installation methods and machinery
- Compaction levels and other mechanical forces

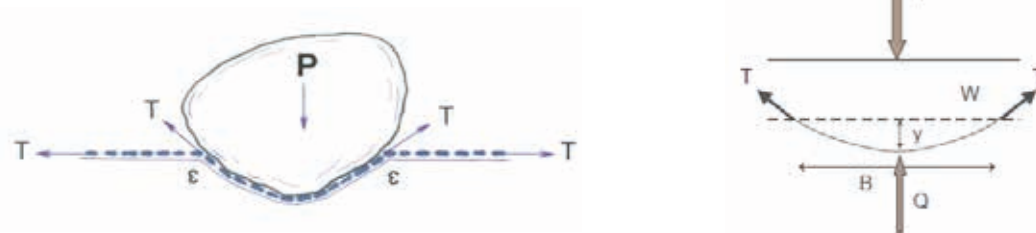

Figure 6.5 Real site conditions and a simplified model for stress/strain evaluation

A simple theoretical model for the required or relevant level of strain of the geotextile has been suggested by J.P. Giroud, /Giroud, J. P., 1999. The concept of constant energy for specifying geotextiles used as separators: Theory and practice. Proceedings of Rencontres 99, Bordeaux, pp. 245-264./

$$1 + \epsilon = \frac{T}{T_d} \cdot \arcsin \left(\frac{T_d}{T} \right), \quad \text{where}$$

ϵ = strain in geotextile

T = stress in geotextile

$$T_d = \text{Load stress} = \frac{F}{\pi \cdot B}, \quad \text{where } F = P + W - Q$$

Calculating the strain in the geotextile using this model shows that strains or elongations up to 60% (57.1%) are to be expected in practical installations.

Strain versus load level based on theoretical model

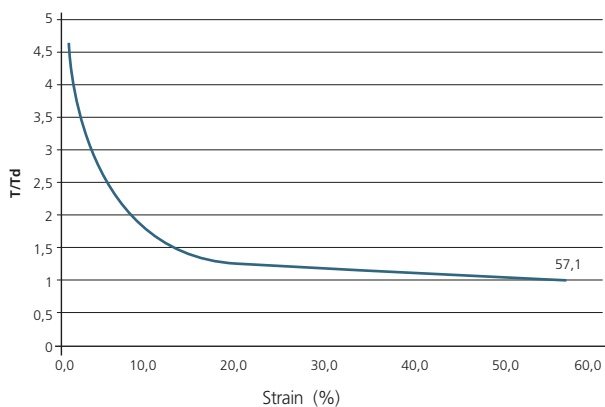

Figure 6.6: Expected level of required strain in practical installations

Even higher levels of strain may in some cases be considered very relevant because of the fact that impacts often happens more than once.

Using the theoretical model, together with the experiences from performed practical installations and installation trials, it is possible to set up acceptable design approaches. This has been done in several national and area-specific guidelines and specifications. Today, specific national or regional requirements referring to the Energy Index or CBR are being applied, for example in the Nordic countries, Switzerland and Germany, and more national design guidelines are moving in this direction, for example in France.

6.5 Practical approach for Fibertex Geotextiles

Using a summary of the above-mentioned different national approaches as a basis, the following general guidelines can be used to select the appropriate mechanical characteristics of the geotextile depending on the application.

Common for all applications is that the main requirement is the Energy Index accompanied by a requirement to the CBR strength. The model for the required Energy Index is set up using correction factors depending on the application and installation methods:

$$IE_{req} = IE_{basis} \cdot \prod_1^x CF_x \quad , \text{ where}$$

IE_{basis} = Basic requirement to Energy Index for the application. (Covers the minimum requirements to the product when installed.)

CF_1 = Correction factor relevant for the specific application and installation

CF_2 = Correction factor relevant for the specific application and installation

CF_x = Correction factor relevant for the specific application and installation

By using this method, a common and well-defined method is established. The used correction factors are regarded as being the most important parameters which influence the product requirements. The number and value of the correction factors can vary from application to application. For typical applications such as:

- Drainage trench installation
- Separation and filtration in hydraulic constructions such as dams and smaller coastal protection constructions
- Separation and filtration in road construction

The specific model using the Energy Index has been set up.

6.6 Fibertex design approach

Due to different national specifications, quality certifications and design guidelines, the grades and characteristics required may be different in the different countries. In that case, these requirements supersede the requirements calculated using methods from this note.

For full design specifications, including requirements re resistance to damage during installation and lifetime and durability properties, the calculation tool at www.fibertex.com can be used.

6.7 Drainage trench installations

For typical drainage trench designs, see Figure 6.7, the required Energy Index model has been established, with the specific description of the correction factors.

The correction factors for drainage trench installations are regarded to be functions of:

CF (drop height when filling the trench, size of filling material, shape of filling material)



Figure 6.7 Example of a drainage trench installation

$$EI_{req} = EI_{basis} \cdot CF_1 \cdot CF_2 \cdot CF_3 \quad , \text{ where}$$

EI_{basis} : For drainage trench installations with an expected lifetime of up to 25 years the basic requirement is set to 1.25 kN/m.

CF_1 = Factor for drop height when filling the trench.

Corr. factor CF_1	Drop height when filling the trench H (m)
1	< 1
1.5	1 - 2
2	> 2

CF_2 = Factor for size of filling material.

Corr. factor CF_2	Size of filling material d_{max} (mm)
1	$d_{max} \leq 32$ mm
1.2	$32 < d_{max} \leq 64$ mm
1.4	$64 < d_{max} \leq 150$ mm

CF_3 = Factor for shape of filling material.

Corr. factor CF_3	Shape of filling material (-)
1	Rounded
1.25	Sharp

Using this model, the required Energy Index is between 1.25 and 4.4 kN/m depending on the conditions.

6.8 Example – drainage trench

A drainage trench, as shown in Figure 6.8, is to be designed using the appropriate geotextile.

The trench is filled from a height of 1.5 m, and filled with rounded stones with a maximum diameter of 50 mm.

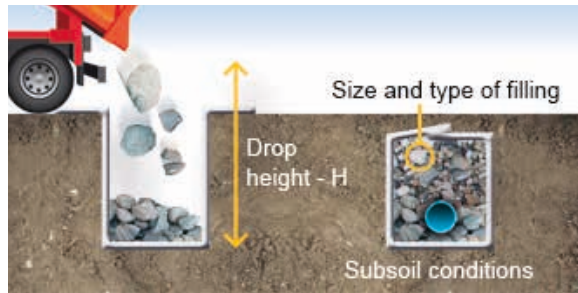

Figure 6.8: Example of drainage trench - installation and design

The required Energy Index is:

$$EI_{req} = EI_{basis} \cdot CF_1 \cdot CF_2 \cdot CF_3 = 1.25 \cdot 1.5 \cdot 1.2 \cdot 1.0 = 2.25 \text{ kN/m}$$

For full design specifications, including requirements regarding hydraulic properties and durability properties, the calculation tool at www.fibertex.com can be used.

6.9 Hydraulic structures

For typical hydraulic structures for coastal protection designs, the required Energy Index model has been established, with the specific description of the correction factors.

The correction factors for hydraulic structures for coastal protection installations are regarded to be functions of:
 CF (subsoil conditions, weight of armour rock, method of installation).



Figure 6.9: Example of a hydraulic structure for coastal protection

$$EI_{req} = EI_{basis} \cdot CF_1 \cdot CF_2 \cdot CF_3 \quad , \text{ where}$$

EI_{basis} : For hydraulic structures for coastal protection, with an expected lifetime of up to 25 years, the basic requirement is set to 6 kN/m.

CF_1 = Factor for for subsoil conditions.

Corr. factor CF_1	Subsoil conditions (- / CBR %)
1	Medium subsoil (CBR 3 - 6)
1.3	Firm subsoil (CBR above 6)

CF_2 = Factor for weight of armour rock.

Corr. factor CF_2	Weight of armour rock (kg)
1	< 150 kg (d < 450 mm)
1.2	150 - 300 kg (d = 450 - 600 mm)
1.6	300 - 500 kg (d = 600 - 700 mm)

CF_3 = Factor for method of installation.

Corr. factor CF_3	Method of installation (-)
1	Step by step
2	Drop height < 2 m

Using this model, the required Energy Index is between 6 and 25 kN/m depending on the conditions.

For permanent installations, the durability aspect should be considered and the requirements in this context should be specified. For more information, see Chapter 7 Durability.

6.10 Example – coastal protection

Coastal protection using armour rock and a geotextile for separation and filtration is to be installed as shown in Figure 6.10. The appropriate geotextile needs to be designed. The armour rock, weighing up to 400 kg, is dropped from a height of 1.5 m. The subsoil consists of clayey sand with a CBR of 4%.

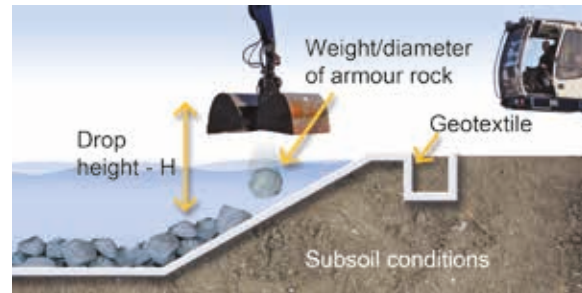

Figure 6.10 Example of hydraulic structure - installation and design

The required Energy Index is:

$$EI_{req} = EI_{basis} \cdot CF_1 \cdot CF_2 \cdot CF_3 = 6.0 \cdot 1.0 \cdot 1.6 \cdot 2.0 = 19.2 \text{ kN/m}$$

For full design specifications, including requirements regarding hydraulic properties and durability properties, the calculation tool at www.fibertex.com can be used.

6.11 Road construction

For typical road constructions using geotextiles as filtration and separation elements to prevent intermixing of aggregate and subsoil, the required Energy Index model has been set up, with the specific description of the correction factors.

The correction factors for road construction installations are regarded to be functions of: CF (subsoil conditions, construction conditions, traffic load, filling/aggregate material)



Figure 6.14 : Exemple de construction de route

$$EI_{req} = EI_{basis} \cdot CF_1 \cdot CF_2 \cdot CF_3 \cdot CF_4 \quad , \text{ where}$$

EI_{basis} : For road construction installations with an expected lifetime of up to 25 years, the basic requirement is set to 1.75 kN/m.

CF_1 = Factor for for subsoil conditions.

Corr. factor CF_1	Subsoil conditions (- / CBR %)
1	Firm subsoil CBR ≥ 3
1.2	Medium subsoil $1 < CBR < 3$
1.4	Weak subsoil CBR ≤ 1

CF_2 = Factor for constructions conditions.

Corr. factor CF_2	Construction conditions (-)
0.9	Low construction traffic and low compaction impact
1.1	Normal construction traffic and normal compaction impact
1.3	Heavy construction traffic and heavy compaction impact

CF_3 = Factor for traffic load.

Corr. factor CF_3	Traffic load (-)
1	Normal - Access roads, small roads (<500 vehicles per day)
1.25	High - Medium and high-volume roads (>500 vehicles per day)

CF_4 = Factor for filling/aggregate material.

Corr. factor CF_4	Filling material / Aggregate (-)
1	Rounded material $d_{max} < 64$ mm
1.3	Rounded material $d_{max} < 200$ mm and sharp material $d_{max} < 64$ mm
1.6	Sharp material $d_{max} < 200$ mm

Using this model, the required Energy Index is between 1.6 and 6.4 kN/m depending on the conditions.

For permanent installations, the durability aspect should be considered, and the requirements in this relation should be specified. For more information, see Chapter 7 "Durability requirements to geotextiles".

6.12 Example – road construction

A geotextile with the functions “filtration” and “separation” is to be installed in a permanent road construction, according to the following information:

Road: permanent road with low traffic
 Subsoil: clayey sand with a CBR of 2%.
 Construction conditions: is to be installed using normal machinery and compaction level.

The aggregate, with a thickness of 400 mm, is installed using sharp gravel and stones with diameters up to 60 mm.

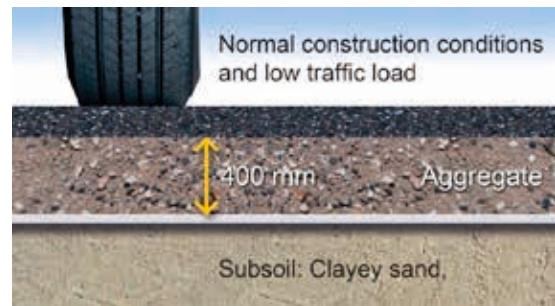

Figure 6.12 Example of road construction - installation and design

The required Energy Index is:

$$EI_{req} = EI_{basis} \cdot CF_1 \cdot CF_2 \cdot CF_3 \cdot CF_4 = 1.75 \cdot 1.2 \cdot 1.1 \cdot 1.0 \cdot 1.3 = 3.0 \text{ kN/m}$$

For full design specifications, including requirements regarding hydraulic properties and durability properties, the calculation tool at www.fibertex.com can be used.

7. Durability requirements to geotextiles

7.1 Background

Depending on the service life of the structure, and the service life of the geotextile functions being used in the structure, it is essential that the durability requirements to the geotextile are specified, including the requirements during the installation period.

When expressing requirements to the durability of the geotextile, the harmonised application standards annex B is used as reference, supported by the following standards:

- EN 12224 Resistance to weathering
- EN 12225 Resistance to microbiological degradation
- EN 14030 Resistance to chemical degradation
- EN 13438 Resistance to oxidation

For the CE-marking, the service life for geotextiles is divided into two levels according to the European application standards:

For temporary applications and structures:

- A durability of min. 5 years is required.

For more permanent applications and structures:

- A durability of min. 25 years is required.

The service life represents a minimum indication. The real working life may, for normal conditions of use, turn out to be considerably longer without major degradation affecting the essential requirements.

7.2 Resistance to weathering

All geotextiles must pass the accelerated weathering test according to EN 12224, unless they are to be covered on the day of installation. The strength retained by the product at the end of this test, together with the specific application of the product, determines the allowable exposure time on site. The maximum exposure times are given in Figure 7.1. Extended testing is necessary for materials which will be exposed for a longer duration.

Application	Retained strength	Maximum time of exposure after installation
Reinforcement or other applications where long-term strength is a significant parameter	> 80% 60 % to 80 % < 60 %	1 month* 2 weeks 1 day
Other applications	> 60 % 20 % to 60 % < 20 %	1 month* 2 weeks 1 day
*) Exposure of up to 4 months may be acceptable depending on the season and on the location in Europe.		

Figure 7.1 Maximum exposure times depending on application and retained strength after evaluation. /EN 12224/

A geotextile which has not been tested for resistance to weathering must be covered within 1 day. The product information shall state: "To be covered within (duration) after installation", using the duration times shown in Figure 7.1.

Weathering outside Europe

The above requirements are specified for the European market. When the geotextile is used in areas where UV radiation levels are higher, such as the Middle East, Australia and South Africa, the required levels might be higher; see Figure 7.2.

This also covers applications where the geotextile can be exposed for longer periods of time after installation.



Figure 7.2 The relevance of specifying the required weathering properties can be very important. ICFG – training/

Resistance to weathering of Fibertex Geotextiles made of virgin PP fibres

When using Fibertex Geotextiles based on virgin PP fibres, the following rule applies:

“To be covered within 2 weeks after installation”

For applications where the geotextile can be exposed after installation, Fibertex Geotextiles are available with a higher UV resistance level.

7.3 Resistance to microbiological degradation

When installing geotextiles in the soil, it is important to ensure that the geotextile is not affected by the action of fungi and bacteria in the soil.

This is evaluated according to EN 12225. The evaluation applies for geotextiles made of natural fibres and for geotextiles made of recycled material where the composition of the polymers is unknown.

For virgin polypropylene geotextiles and other high-molecular weight synthetic polymers, the evaluation is not needed as these materials are not affected by fungi and bacteria.

Resistance to microbiological degradation of Fibertex Geotextiles made of virgin PP fibres

When using Fibertex Geotextiles based on virgin PP fibres, the following rule applies:

“Microbiological resistance to EN 12225: 100% retained strength”

7.4 Resistance to chemical degradation and oxidation

For geotextiles exposed to soil for a period of up to 25 years, the following forms of chemical degradation should be considered:

- alkaline attack on polyesters
- acid attack on polyamides under aerobic conditions
- oxidation of polypropylene and polyethylene
- internal hydrolysis of polyesters in water or any aqueous solution

A geotextile product consisting of polymers such as polypropylene and polyethylene is susceptible to oxidation and therefore all such materials should be subjected to the accelerated thermal oxidation screening test according to EN ISO 13438. The type of polymer used and the specific application of the geotextile define the length of time and the temperature that the material has to be exposed to the oven ageing. For all applications, the retained strength should exceed 50% of the tensile strength of the reference samples.

Resistance to oxidation of Fibertex Geotextiles made of virgin PP fibres

When using Fibertex Geotextiles based on virgin PP fibres, the following rule applies:

“Oxidation resistance to EN ISO 13438: >90% retained strength”

7.5 Durability – minimum requirements

Depending on polymers used for the geotextile and the available durability properties, the general requirement in the CE-marking of the products can be divided into two levels depending on the required service lifetime:

For required service lives up to 5 years:

“Predicted to be durable for a minimum of 5 years for non-reinforcing applications in natural soils with a pH between 4 and 9 and at a soil temperature <25°C.”

For required service lives up to 25 years:

“Predicted to be durable for a minimum of 25 years in natural soils with $4 < \text{pH} < 9$ and soil temperatures <25°C.”

Durability of Fibertex Geotextiles made of virgin PP fibres

pH levels of the soils or materials in which the geotextiles are installed can often fall outside the pH limits of 4-9 which are the stated limits in the general CE-marking. pH levels below 4 can be found in anaerobic peats or soils which have been affected by acid rain, whereas pH levels above 9 often occur where bentonite and other clays are used in civil engineering construction, such as wall constructions, grouting processes, sealing layers in landfill and tunnelling. Moreover, the leachate coming from landfills may be outside the typical limitations of pH 4-9.

To meet these requirements, Fibertex Geotextiles made of virgin PP fibres have been evaluated according to EN 14030 alkaline and acid attack, allowing a wider pH range of 2-13 to be covered by Fibertex Geotextiles.

“Predicted to be durable for a minimum of 25 years in natural soils with $2 < \text{pH} < 13$ and soil temperatures < 25°C”

For permanent structures, this requirement should be used together with the characteristics for relevant functions when specifying the appropriate geotextile to be used.

8. Handling, storage and installation

8.1 Handling and storage

Fibertex Geotextiles are typically delivered in wide rolls. Unloading should be carefully performed to avoid damaging the geotextiles e.g. using a forklift mounted with a spear, see Figure 8.1.

For storage on-site, the rolls should be placed on e.g. a pallet or planks and well covered from exposure to rain and direct sunlight. The rolls should be protected against vandalism or damage from operating equipment used on site.

The rolls can be cut with a saw. If a chainsaw is used, as shown in Figure 8.2, the cut must be cooled with water to prevent the geotextile from melting. Single layers of geotextile are easily cut with a sharp knife.



Figure 8.1 Unloading the rolls using a forklift mounted with a spear



8.2 Cutting the Fibertex roll with a chainsaw

Fibertex Geotextiles are resistant to acids and alkalis, are not attacked by decay or fungi, however, they should always be kept away from direct sunlight. Unrolled geotextile should be covered within the specified period on the product CE-document, to ensure the functionality of the geotextile. See how to store correct on site in Figure 8.3.



Figure 8.3 Correct storage on site

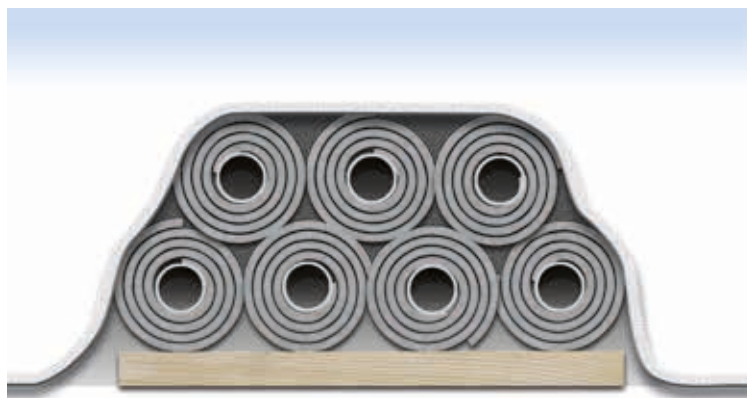

8.2 Installing geotextiles

In addition to the application and function to be covered by the geotextile, it is important to consider the following:

- Before installation, check if the packing foil is complete – if not, check the geotextile roll for damage due to UV radiation or mechanical impacts.
- Before installation of the geotextile, the site must be cleared of large and sharp stones, tree stumps or any other objects that could damage the geotextile.
- Secure the geotextile from wind forces, for example by placing small bags with sand on the fabric to hold it in place.
- If heavy construction equipment is used, driving on the geotextile must be avoided.
- If several rolls of geotextile are used for the installation, joint overlaps should be made correctly, either by sewing or by using adequate overlaps, depending on the application and soil conditions.
- Prior to covering, the geotextiles must be inspected to ensure that the geotextile has not been damaged during installation.

8.3 Joints and overlaps

In installations where more than one roll of geotextile is used, the joint overlaps should be made either by sewing or by using adequate overlaps.

The requirements to the joints depend on the application and soil conditions in question. The larger the deformations which can be expected, the greater the requirements for the overlap. Figure 8.4 can be used as a guideline. The requirements are specified for typical road applications. For larger hydraulic structures, the minimum overlap should never be below 500 mm and is often required to be min. 1 metre.

Soil CBR	Minimum overlap
Greater than 3	300 - 450 mm
1 - 3	0.6 - 1 m
0.5 - 1	1 m or sewn
Less than 0.5	Sewn

Figure 8.4 Overlap requirements /ASSHTO M288/

Sewing is a good alternative to overlapping, especially when the required overlaps are quite large, for example close to and above 1 m. Sewing can be carried out using different types of threads and seams. It is therefore important that the quality of the seam is evaluated. This is typically done by testing the seam according to EN ISO 10321 "Geosynthetics - Tensile test for joints/seams by wide-width strip method".

9. Fibertex calculation tools

To help designers and installers in the general use and choice of geotextiles, the Fibertex design methods have been established using calculation tools which are all found at www.fibertex.com. The tools can be used as guidelines when choosing and specifying geotextiles. The results of the calculations should always be evaluated by a qualified engineer to ensure that project specification requirements are fulfilled.

Due to different national specifications, quality certifications and design guidelines, the grades and characteristics required may differ from country to country. In that case, these requirements supersede the requirements calculated using methods from this note and the calculation tools used.

Disclaimer

The information and calculation tools at www.fibertex.com are designed exclusively to provide the reader and user with general information.

Fibertex Nonwovens A/S aims to ensure that information, formulas, calculation tools etc. are correct. For many reasons, including user PC configuration, frequent changes in product design, materials, laws, humidity, moisture and other environmental factors, local geological deviations, standards and guidelines, there may be errors, delays, omissions or inaccuracies in the information or calculation results. Information can also be changed without notice. No warranty of any kind, whether expressed or implied, including but not limited to the warranties of non-infringement of third-party rights, title, merchantability, fitness for a particular purpose and freedom from computer virus, is given with respect to any use of the information and calculation tools and use of such including the use of results from there.

Fibertex Nonwovens A/S disclaims to the fullest extent possible and for any reason any responsibility for the information and calculation results, nor for any untoward effects of their use, including the use of the calculation tools to design using competitive products. As such, Fibertex Nonwovens A/S as well as its officers, directors, employees, agents and managers, parent companies or other subsidiaries on behalf of whom this disclaimer is issued, shall have no liability or responsibility whatsoever no matter whether it is based on contract, tort or any other legal ground for any inaccuracy, incompleteness, omission, lack of timeliness or any other error of the data, information and/or calculation tools nor for any computer viruses transferred with the data supplied by Fibertex Nonwovens A/S at the website www.fibertex.com. Decisions based on any information or calculations contained through or with the use of the information and calculation tools at www.fibertex.com are the sole responsibility of the user. Thus, Fibertex Nonwovens A/S as well as its officers, directors, employees, agents and managers, parent companies or other subsidiaries shall have in particular no liability or responsibility whatsoever for any direct or indirect or consequential loss to any person, company or any other legal entity and users in general caused by or arising from any information, calculations and the use of any of such – whether correct or incorrect – supplied by Fibertex Nonwovens A/S at the website www.fibertex.com.

Any dispute out of or in connection with the use of the information and calculation tools at www.fibertex.com is subject to the exclusive jurisdiction of the courts of Denmark (the nearest and relevant District Court to the head office of Fibertex Nonwovens A/S) and shall be governed by Danish Law with the exception of the rules under international private law in force at any given time.

Appendix A

To avoid any confusion caused by the fact that different countries/authors use different designations for the same purpose, this terminology is based on following definitions:

$O_{90\%}$ is the characteristic opening size of a geotextile, and expressed in μm (microns) gives information of the maximum grain size able to pass the geotextile. It is measured by wet sieving of a predefined test-grain-mixture, and **$d_{90\%}$ of the material passing the geotextile = $O_{90\%}$**

$d_{90\%}$, $d_{60\%}$, $d_{10\%}$ expressed in μm (microns), all refer to the soil, and $d_{x\%}$ means that for $x\%$ of the soil expressed in μm , the grain sizes will be smaller than μm .

U is the granularity of the subsoil and is the proportion between $d_{60\%}$ and $d_{10\%}$.

For $U < 5$ the subsoil is called uniformly graded (B)

For $U \geq 5$ the subsoil is called well graded (A)

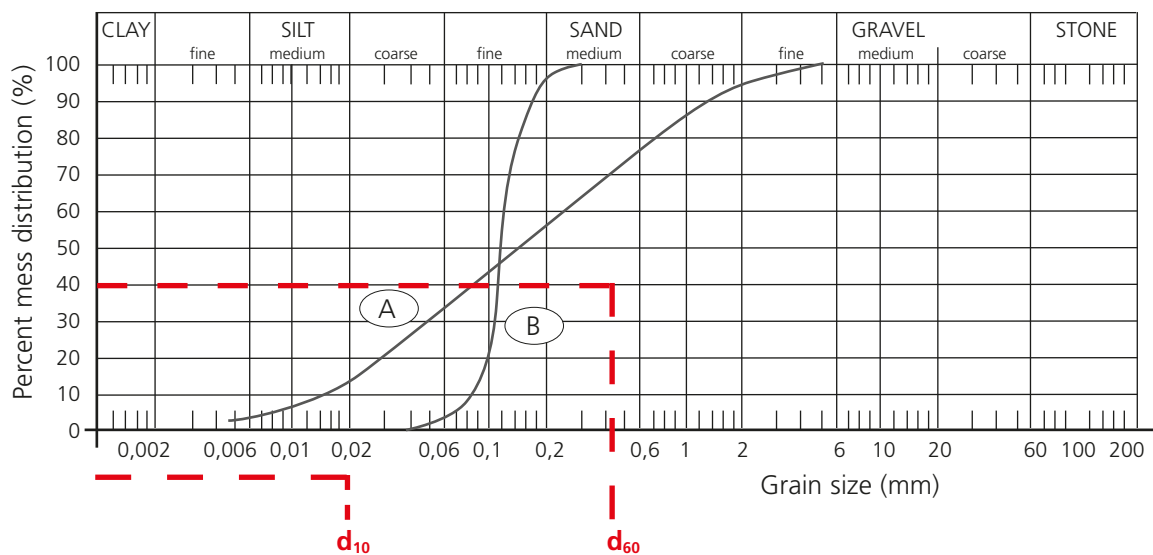

$d_{60} = 0.24 \text{ mm}$ and $d_{10} = 0.14 \text{ mm}$, giving $U = 0.24 \text{ mm} / 0.14 \text{ mm} = 17$

Symbols

Symbol	Unit	Description
k_{xx}	m/s	Coefficient of permeability
V_{H50}	m/s	Velocity Index
i_{xx}	-	Hydraulic gradient
$O_{90\%}$	μm	Characteristic opening size
CF_{xx}	-	Correction factor
FOS	-	Factor of safety
U	-	Granularity defined as d_{60}/d_{10}
d_{xx}	mm	Diameter "Soil" from grain distribution curve
q_{xx}	$\text{l/m}^2 \text{ h}$	Water flow per unit width
Q_{xx}	m^3/s	Water flow
Θ	m^2/s	Transmissivity
W	m	Width of drain, road or ...
H	m	Height of soil cover, layer or ...
L	m	Length of slope, geotextile or ...
γ	kN/m^3	Volume weight of soil water or ...
T_{xx}	kN/m	Tensile stress in geotextile
ϵ	- / %	Strain in geotextile
P	N	Single Force
R	N	Reaction Force
F	N	Force
X	N	Force/Load
EI_{xx}	kN/m	Energy Index = $\frac{1}{2} (T \cdot \epsilon)$
σ	kPa	Stress

References

- 1 EN 12224 (2000) Geotextiles and geotextile-related products - Determination of the resistance to weathering
- 2 EN 12225 (2000) Geotextiles and geotextile-related products - Method for determining the microbiological resistance by a soil burial test
- 3 EN 12226 (2000) Geotextiles and geotextile-related products - General tests for evaluation following durability testing
- 4 EN 13249 (2001) Geotextiles and geotextile-related products - Required characteristics for use in the construction of roads and other trafficked areas
- 5 EN 13250 (2001) Geotextiles and geotextile-related products - Required characteristics for use in the construction of railways
- 6 EN 13251 (2001) Geotextiles and geotextile-related products - Required characteristics for use in earthworks, foundations and retaining structures
- 7 EN 13252 (2001) Geotextiles and geotextile-related products - Required characteristics for use in drainage systems
- 8 EN 13253 (2001) Geotextiles and geotextile-related products - Required characteristics for use in erosion control systems
- 9 EN 13254 (2001) Geotextiles and geotextile-related products - Required characteristics for use in the construction of reservoirs and dams
- 10 EN 13255 (2001) Geotextiles and geotextile-related products - Required characteristics for use in the construction of canals
- 11 EN 13256 (2001) Geotextiles and geotextile-related products - Required characteristics for use in the construction of tunnels and underground structures
- 12 EN 13257 (2001) Geotextiles and geotextile-related products - Required characteristics for use in solid waste disposals
- 13 EN 13265 (2001) Geotextiles and geotextile-related products - Required characteristics for use in liquid waste containment project
- 14 EN 13719 (2002) Geotextiles and geotextile-related products - Determination of the long term protection efficiency of geotextiles in contact with geosynthetic barriers
- 15 EN 14574 (2005) Geosynthetics - Determination of the pyramid puncture resistance of supported geosynthetics
- 16 EN ISO 10318 (2005) Geosynthetics - Terms and definitions
- 17 EN ISO 10319 (2008) Geosynthetics - Wide-width tensile test
- 18 EN ISO 11058 (2010) Geotextiles and geotextile-related products - Determination of water permeability characteristics normal to the plane, without load
- 19 EN ISO 12236 (2006) Geosynthetics - Static puncture test (CBR test)
- 20 EN ISO 13433 (2006) Geosynthetics - Dynamic perforation test (cone drop test)
- 21 EN ISO 12956 (2010) Geotextiles and geotextile-related products - Determination of the characteristic opening size
- 22 EN ISO 12958 (2010) Geotextiles and geotextile-related products - Determination of water flow capacity in their plane
- 23 EN 14030 (2001) Geotextiles and geotextile-related products - Screening test method for determining the resistance to acid and alkaline liquids
- 24 EN ISO 13438 (2004) Geotextiles and geotextile-related products - Screening test method for determining the resistance to oxidation
- 25 DS CEN CR ISO 13434 (1999) Guidelines on durability of geotextiles and geotextile-related products
- 26 NF G 38 061 Recommandations pour l'emploi des géotextiles et produits apparentés. Détermination des caractéristiques hydrauliques et mise en œuvre des géotextiles et produits apparentés utilisés dans les systèmes de drainage et de filtration
- 27 A. Watn, Eiksund, G & Knutson, Å. (1998) Deformations and damage of non-woven geotextiles in road construction. 6th ICG, Atlanta, USA 1998, pp 933-938.
- 28 A. Watn, S.H. Chew (2002) Geosynthetic damage - from laboratory to field, Geosynthetics - 7th ICG - Delmas, Gourc & Girard 2002, pp 1203-1224
- 29 David A. Shercliff (1998) Designing with the cylinder test, The Re-use of Contaminated Land and Landfills 7th - 9th July 1998, Brunel University, London
- 30 Fibertex Design guide (2002) Fibertex Design guide, Aalborg, 2002
- 31 Fibertex Handbook (1996) Fibertex Geotekstiler, 1996
- 32 Forschungsgesellschaft für Strassen- und Verkehrswesen (2005) Merkblatt über die Anwendung von Geokunststoffen im Erdbau des strassenbaues, M Geok E, Ausgabe 2005
- 33 French committee of geotextiles and geomembranes (1986) CFGG, Geotextiles manual UK version, section 1 to 7. France 1986
- 34 J. P. Giroud (1999) Le concept d'énergie pour les spécifications des géotextiles utilisés comme séparateurs: la théorie et la pratique. Comptes Rendus de Rencontres 99. Bordeaux, France: Comité Français des Geosynthétiques.
- 35 Norgeospec (2002) A Nordic system for specification and control of geotextiles in roads and other trafficked areas
- 36 Rüeegger Rudolf & Hufenus Rudolf (2003) Schweizerischer Verband für Geokunststoffe SVG: "Bauen mit Geokunststoffen", St. Gallen 2003
- 37 SINTEF (1996) Non-woven geotextiles in road constructions. Report STF22 F96656. Trondheim, Norway: SINTEF.
- 38 SINTEF (1997) Non-woven geotextiels- filed test on damage during installation. Report STF22F976658. Trondheim, Norway: SINTEF
- 39 AASHTO M 288-05 (2005) Standard specifications for geotextiles. Geotextile Specification for Highway Applications ASSHTO M288-05

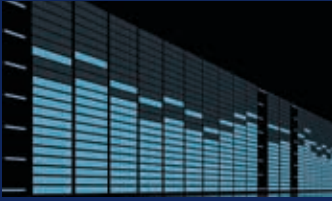

Acoustics



Automotive



Bedding



Building Industry



Composites



Concrete



Flooring



Filtration



Furniture



Geotextiles



Home & Garden



Medico



Wipes



FIBERTEX.COM

Fibertex Nonwovens A/S
 Svendborgvej 16
 DK-9220 Aalborg Ø
 Denmark
 Tel. +45 96 35 35 35
 Fax +45 98 15 85 55
 fibertex@fibertex.com
 www.fibertex.com

